

Job Name:

System Reference:

Date:

**UNIT OPTION**

Standard Model.....PUMY-P48NKMU3
Seacoast (BS) Model.....PUMY-P48NKMU3-BS

ACCESSORIES

Drain Socket.....PAC-SG61DS-E
Optional Defrost Heater.....PAC-SJ20BH-E
Drain Pan.....PAC-SH97DP-E
Front Wind Baffle (One Piece).....WB-PA3
Air Deflector Vertical.....ADV-1
Air Outlet Guide (One Piece).....PAC-SH96SG-E
Header Kit.....for details see Pipe Accessories Submittal
Joint Kit.....for details see Pipe Accessories Submittal

*PUMY requires two outlet guides and two wind baffles for installation

Specifications			System
Unit Type			PUMY-P48NKMU3(-BS)
Cooling Capacity (Nominal)		BTU/H	48,000
Heating Capacity (Nominal)		BTU/H	54,000
Guaranteed Operating Range	Cooling ^{1,2}	°F [°C]	5~115 [-15.0~46.0]
	Heating	°F [°C]	-13~59 [-25.0~15.0]
External Dimensions (H x W x D)		In. [mm]	52-11/16 x 41-11/32 x 13+1 [1,338 x 1050 x 330+25]
Net Weight		Lbs. [kg]	271 [123]
External Finish			Galvanized sheets (+power coating for -BS type)
Electrical Power Requirements	Voltage, Phase, Hertz, Power Tolerance		208/230V, 1-phase, 60 Hz,
Minimum Circuit Ampacity		A	29.0
Maximum Overcurrent Protection		A	44
Recommended Fuse Size		A	30
SCCR		kA	5
Refrigerant Piping Diameter	Liquid (High Pressure)	In. [mm]	3/8 [9.52] Flare
	Gas (Low Pressure)	In. [mm]	5/8 [15.88] Flare
Indoor Unit Connectable	Total Capacity		50.0~130.0% of outdoor unit capacity
	Model/Quantity		P04~P54/1.0~12.0
Sound Pressure Levels		dB(A)	51.0~54.0
FAN	Type x Quantity		Propeller fan x 2
	Fan Motor Output	kW	0.074 + 0.074 (two fan motors)
	Airflow Rate	CFM	3885
Compressor Operating Range		Cooling	28.0% to 100.0 %
		Heating	18.0% to 100.0%
Compressor	Type x Quantity		INVERTER-driven Scroll Hermetic x 1
Compressor Motor Output		kW	3.3
Refrigerant	Type x Original Charge		R410A x 10 lbs + 9.0 oz [4.8 kg]
Protection Devices	High Pressure Protection		High pressure sensor, High pressure switch 601 psi (4.15 MPa)
	Inverter Circuit (Comp./Fan)		Over-heat protection, Over-current protection
	Compressor		Discharge thermo protection, Over-current protection
Lubricant			FV50S (2.3 liters)
AHRI Ratings (Ducted/Non-ducted)	EER		11.3/13.1
	SEER		16.5/22.6
	COP		3.3/4.0
	HSPF		11.0/12.0
	ENERGY STAR® Certified		No/Yes

NOTES:

Cooling | Indoor: 81 ° F (27 ° C) DB / 66 ° F (19 ° C) WB; Outdoor: 95 ° F (35 ° C) DB

Heating | Indoor: 68° F (20° C) DB, Outdoor 45° F (7° C) DB / 43° F (6° C) WB

¹When using Wind Baffles [WB-PA3], the minimum operating range is 5° F. Without Wind Baffles, the minimum operating range is 23° F²When connecting PKFY-P06NBMU/P08NHMU, PFFY-P06/08/12NEMU or PFFY-P06/08/12NRMU indoor units, the minimum operating range is 50° F

DIMENSIONS: PUMY-P48NKMU3(-BS)

Unit: mm(in)

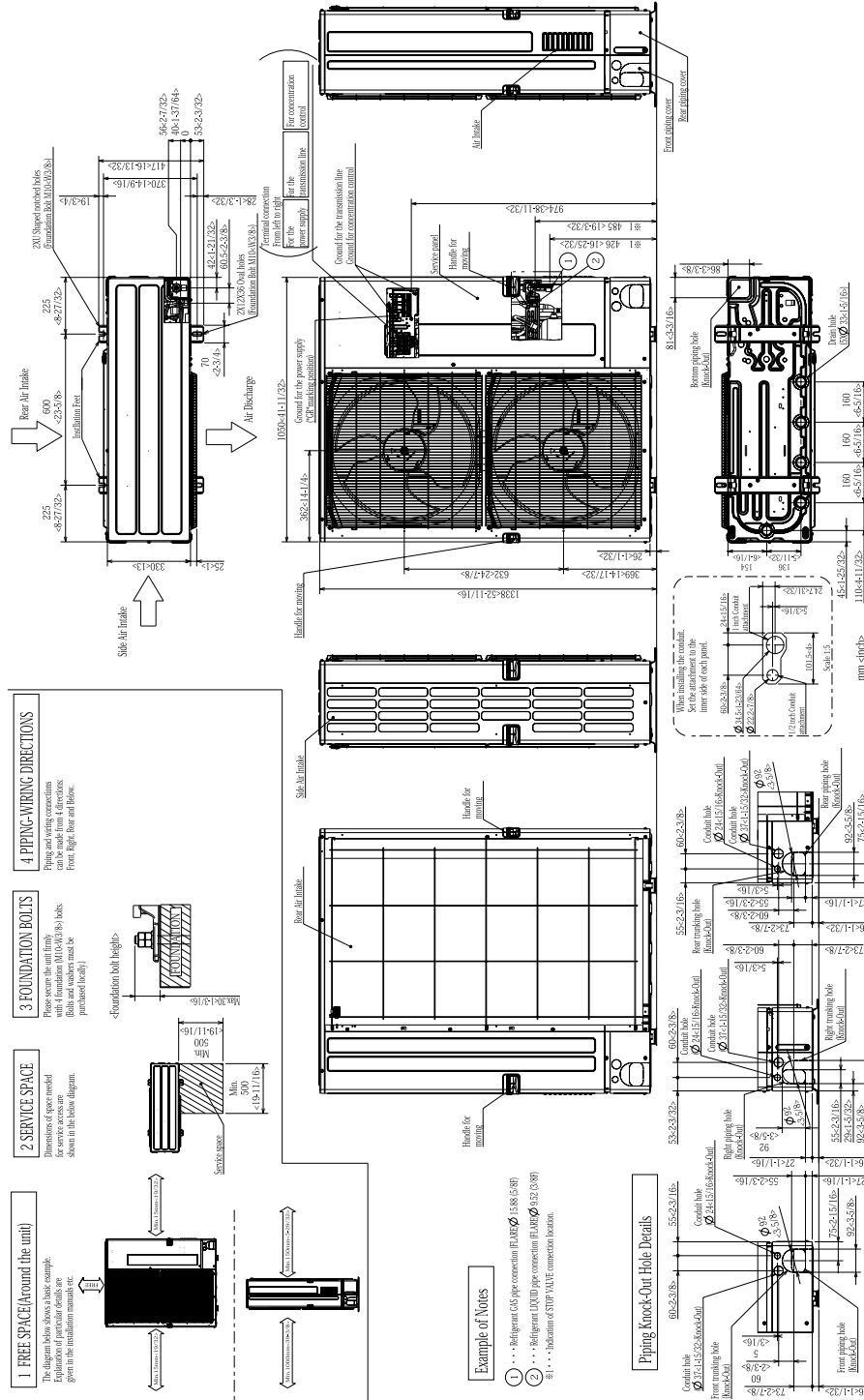

NOTES:
SEACOAST PROTECTION
 Anti-corrosion Protection: A coating treatment is applied to condenser coil for protection from air contaminants.
 Standard: Salt Spray Test Method - no unusual rust development to 480 hours.
 Sea Coast (BS): Salt Spray Test Method (JRA 9002) - no unusual rust development to 960 hours.

1340 Satellite Boulevard Suwanee, GA 30024
 Toll Free: 800-433-4822 www.mehvac.com

FORM# PUMY-P48NKMU3(-BS) - 202107



Heat Pump

Model name:

MCY-MAP_7HS-UL

Engineering Data Book



Notice: Toshiba is committed to continuously improving its products to ensure the highest quality and reliability standards, and to meet local regulations and market requirements. All features and specifications are subject to change without prior notice.









	Safety caution	2
1	System overview	5
	1-1. Allocation standard of model name	5
	1-2. Summary of system equipments	6
2	Equipment selection procedure	9
	2-1. Selection flow chart.....	9
	2-2. Combination conditions for indoor unit and outdoor unit	10
	2-3. Cooling/heating capacity characteristics.....	11
	2-4. Operational temperature range.....	17
3	Refrigerant piping design.....	18
	3-1. Free branching system	18
	3-2. Allowable length/height difference of refrigerant piping	19
	3-3. Selection of refrigerant piping	20
	3-4. Charging requirement with additional refrigerant.....	21
4	Wiring design.....	22
	4-1. General	22
	4-2. Outdoor unit power supply	22
	4-3. Indoor unit power supply	23
	4-4. Design of control wiring	24
5	Outdoor unit.....	26
	5-1. Specifications.....	26
	5-2. Dimensional drawing	28
	5-3. Center of gravity	29
	5-4. Branch header / Branch joint	30
	5-5. Refrigerant cycle diagram.....	31
	5-6. Wiring diagram.....	32
	5-7. Connecting diagram.....	33
	5-8. Applied control for Outdoor Unit	34
	5-9. Optional printed circuit board (PCB) of outdoor unit.....	35
	5-10. Sound pressure level data	41



- Before use, read carefully through the “Safety caution” section to ensure correct operation.
- The important contents concerned to the safety are described in the “Safety cautions”. Be sure to keep them. For Indications and their meanings, see the following description.

■ Warning Indications on the Air Conditioner Unit

Warning indication		Description					
 <table border="1"> <tr> <td colspan="2">WARNING</td> </tr> <tr> <td colspan="2">ELECTRICAL SHOCK HAZARD</td> </tr> <tr> <td colspan="2">Disconnect all remote electric power supplies</td> </tr> </table>	WARNING		ELECTRICAL SHOCK HAZARD		Disconnect all remote electric power supplies		WARNING ELECTRICAL SHOCK HAZARD Disconnect all remote electric power supplies before servicing.
WARNING							
ELECTRICAL SHOCK HAZARD							
Disconnect all remote electric power supplies							
 <table border="1"> <tr> <td colspan="2">WARNING</td> </tr> <tr> <td colspan="2">Moving parts.</td> </tr> <tr> <td colspan="2">Do not operate unit with grille removed.</td> </tr> </table>	WARNING		Moving parts.		Do not operate unit with grille removed.		WARNING Moving parts. Do not operate unit with grille removed. Stop the unit before servicing.
WARNING							
Moving parts.							
Do not operate unit with grille removed.							
 <table border="1"> <tr> <td colspan="2">CAUTION</td> </tr> <tr> <td colspan="2">High temperature parts.</td> </tr> <tr> <td colspan="2">You might get burned when removing this panel.</td> </tr> </table>	CAUTION		High temperature parts.		You might get burned when removing this panel.		CAUTION High temperature parts. You might get burned when removing this panel.
CAUTION							
High temperature parts.							
You might get burned when removing this panel.							
 <table border="1"> <tr> <td colspan="2">CAUTION</td> </tr> <tr> <td colspan="2">Do not touch the aluminum fins of the unit.</td> </tr> <tr> <td colspan="2">Doing so may result in injury.</td> </tr> </table>	CAUTION		Do not touch the aluminum fins of the unit.		Doing so may result in injury.		CAUTION Do not touch the aluminium fins of the unit. Doing so may result in injury.
CAUTION							
Do not touch the aluminum fins of the unit.							
Doing so may result in injury.							
 <table border="1"> <tr> <td colspan="2">CAUTION</td> </tr> <tr> <td colspan="2">BURST HAZARD</td> </tr> <tr> <td colspan="2">Open the service valves before the operation,</td> </tr> </table>	CAUTION		BURST HAZARD		Open the service valves before the operation,		CAUTION BURST HAZARD Open the service valves before the operation, otherwise there might be the burst.
CAUTION							
BURST HAZARD							
Open the service valves before the operation,							
 <table border="1"> <tr> <td colspan="2">CAUTION</td> </tr> <tr> <td colspan="2">Do not climb onto the fan guard.</td> </tr> <tr> <td colspan="2">Doing so may result injury</td> </tr> </table>	CAUTION		Do not climb onto the fan guard.		Doing so may result injury		CAUTION Do not climb onto the fan guard. Doing so may result in injury.
CAUTION							
Do not climb onto the fan guard.							
Doing so may result injury							

■ **Explanation of indications**

 **WARNING**

Improper handling of equipment could lead to serious injury or death.

 **CAUTION**

Improper installation of the equipment could lead to minor injury or property damage.

- After installation work is completed, please run the system in test mode for proper operation and explain the maintenance schedules to the customer as outlined in owner's manual. Please ask the customer to retain the installation and owner's manual for future reference.

 **WARNING**

The system should be installed by trained professional contractor by the factory.

Take precaution so that the refrigerant does not exceed the limit concentration even if it leaks when installing the unit in a small room.

Installation site location should be able to support the weight on the unit.

Ensure the room is properly ventilated in case of refrigerant leak during installation.

Leakage test should be performed to ensure there are no refrigerant leaks after installation.

Empty refrigerant cylinder should be used to recover the refrigerant from the system during repair or re-installation work.

Do not store system refrigerant at outdoor unit.

Certified electrician should perform all the electrical work in order to comply with national and local codes and regulations.

Use of proper size and type of wires is recommended for electrical and controls communication.

Ensure proper grounding of wire is carried out as needed through out the system.

 **CAUTION**

Avoid installation of the unit close to combustible gas or highly corrosion areas.

Be sure to attach an earth leakage breaker; otherwise an electric shock may be caused.

Using a torque wrench, tighten the flare nut in the specified method.

If the flare nut is exceedingly tightened, the flare nut is broken and a refrigerant leakage may be caused after a long time has passed.

WARNINGS ON REFRIGERANT LEAKAGE

Concentration Limit Check

The room in which the air conditioner is to be installed requires a design that in the event of a refrigerant gas leak, its concentration will not exceed a set limit.

The refrigerant R410A which is used in the air conditioner is safe, without the toxicity or combustibility of ammonia, and is not restricted by laws to be imposed which protect the ozone layer. However, since it contains more than air, it poses the risk of suffocation if its concentration should rise excessively. Suffocation from leakage of R410A is almost nonexistent. With the recent increase in the number of high concentration buildings, however, the installation of multi air conditioner systems is on the increase because of the need for effective use of floor space, individual control, energy conservation by curtailing heat and carrying power etc.

Most importantly, the multi air conditioner system is able to replenish a large amount of refrigerant compared with conventional individual air conditioners. If a single unit of the multi conditioner system is to be installed in a small room, select a suitable model and installation procedure so that if the refrigerant accidentally leaks out, its concentration does not reach the limit (and in the event of an emergency, measures can be made before injury can occur).

In a room where the concentration may exceed the limit, create an opening with adjacent rooms, or install mechanical ventilation combined with a gas leak detection device.

Use the following calculation to determine the correct amount.

$$\frac{\text{Total amount of refrigerant (lbs (kg))}}{\text{Min. volume of the indoor unit installed room ft}^3 \text{ (m}^3\text{)}} \leq \text{Concentration limit (lbs/ft}^3 \text{ (kg/m}^3\text{))}$$

Concentration limit

Compliance to the local applicable regulations and standards for the concentration limit is required.

NOTE 1:

If there are 2 or more refrigerating systems in a single refrigerating device, the amounts of refrigerant should be as charged in each independent device.

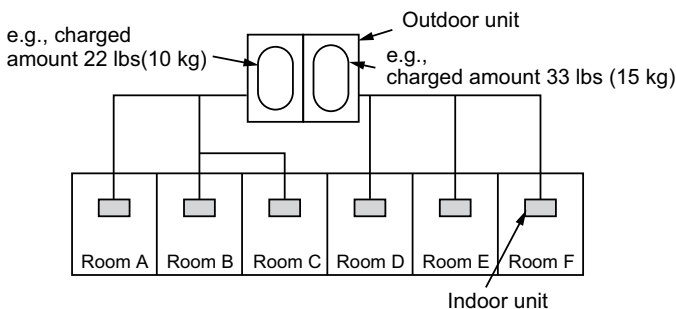

For the amount of charge in this example:

The possible amount of leaked refrigerant gas in rooms A, B and C is 22 lbs (10 kg).

The possible amount of leaked refrigerant gas in rooms D, E and F is 33 lbs (15 kg).

Important

NOTE 2:

The standards for minimum room volume are as follows.

- (1) No partition (shaded portion)

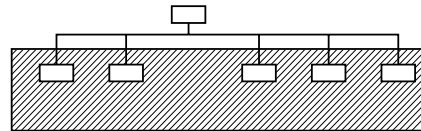

- (2) When there is an effective opening with the adjacent room for ventilation of leaking refrigerant gas (opening without a door, or an opening 0.15 % or larger than the respective floor spaces at the top or bottom of the door).

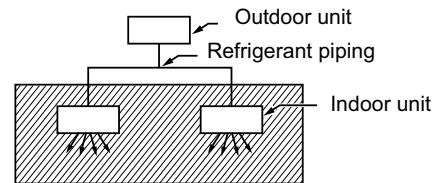

- (3) If an indoor unit is installed in each partitioned room and the refrigerant piping is interconnected, the smallest room becomes the object. However when a mechanical ventilation is installed interlocked with a gas leakage detector in the smallest room where the density limit is exceeded, the volume of the next smallest room becomes the object.

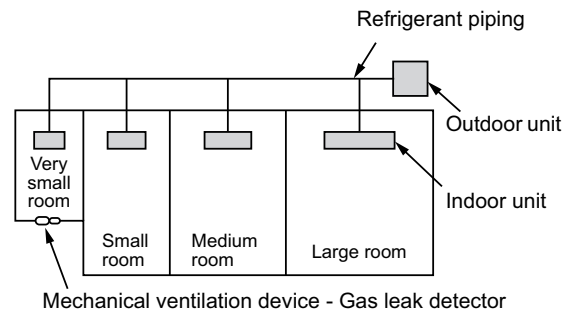



1-1. Allocation standard of model name

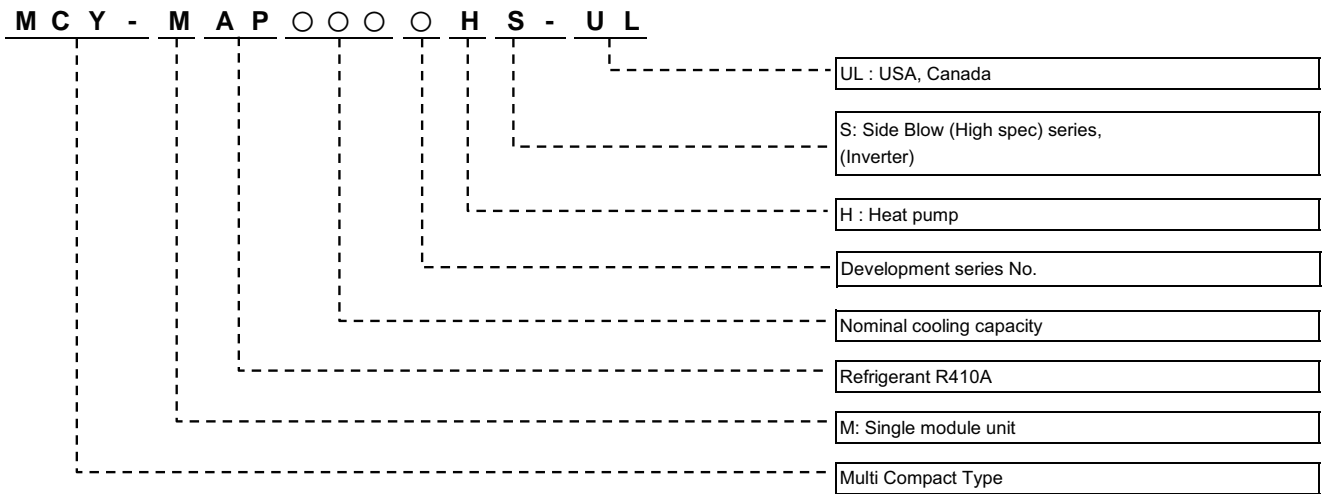



1-2. Summary of system equipments

1-2-1. Outdoor units



Unit type			Inverter unit			Appearance 
Model name	208/230 V, 60 Hz	MCY-	MAP0367HS-UL	MAP0487HS-UL	MAP0607HS-UL	
Capacity type			036 type	048 type	060 type	
Capacity code			36	48	60	



1-2-2. Indoor unit

Type	Appearance	Model name	Capacity type	Capacity code	Cooling capacity (kBTU/h)	Heating capacity (kBTU/h)
4-Way Cassette		MMU-UP0071HP-UL	007 type	7.5	7.5	8.5
		MMU-UP0091HP-UL	009 type	9.5	9.5	10.5
		MMU-UP0121HP-UL	012 type	12	12	13.5
		MMU-UP0151HP-UL	015 type	15.4	15.4	17
		MMU-UP0181HP-UL	018 type	18	18	20
		MMU-UP0241HP-UL	024 type	24	24	27
		MMU-UP0301HP-UL	030 type	30	30	34
		MMU-UP0361HP-UL	036 type	36	36	40
		MMU-UP0421HP-UL	042 type	42	42	47.5
Compact 4-Way Cassette		MMU-UP0071MH-UL	007 type	7.5	7.5	8.5
		MMU-UP0091MH-UL	009 type	9.5	9.5	10.5
		MMU-UP0121MH-UL	012 type	12	12	13.5
		MMU-UP0151MH-UL	015 type	15.4	15.4	17
		MMU-UP0181MH-UL	018 type	18	18	20
1-way Cassette		MMU-UP0071YHP-UL	007 type	7.5	7.5	8.5
		MMU-UP0091YHP-UL	009 type	9.5	9.5	10.5
		MMU-UP0121YHP-UL	012 type	12	12	13.5
		MMU-UP0151YHP-UL	015 type	15.4	15.4	17
		MMU-UP0181YHP-UL	018 type	18	18	20
Ceiling		MMC-UP0181HP-UL	018 type	18	18	20
		MMC-UP0241HP-UL	024 type	24	24	27
		MMC-UP0301HP-UL	030 type	30	30	34
		MMC-UP0361HP-UL	036 type	36	36	40
High Wall		MMK-UP0071HP-UL	007 type	7.5	7.5	8.5
		MMK-UP0091HP-UL	009 type	9.5	9.5	10.5
		MMK-UP0121HP-UL	012 type	12	12	13.5
		MMK-UP0151HP-UL	015 type	15.4	15.4	17
		MMK-UP0181HP-UL	018 type	18	18	20
		MMK-UP0241HP-UL	024 type	24	24	27
Slim Duct		MMD-UP0071SPH-UL	007 type	7.5	7.5	8.5
		MMD-UP0091SHP-UL	009 type	9.5	9.5	10.5
		MMD-UP0121SHP-UL	012 type	12	12	13.5
		MMD-UP0151SHP-UL	015 type	15.4	15.4	17
Medium Static Duct		MMD-UP0181SHP-UL	018 type	18	18	20
		MMD-UP0071BHP-UL	007 type	7.5	7.5	8.5
		MMD-UP0091BHP-UL	009 type	9.5	9.5	10.5
		MMD-UP0121BHP-UL	012 type	12	12	13.5
		MMD-UP0151BHP-UL	015 type	15.4	15.4	17
		MMD-UP0181BHP-UL	018 type	18	18	20
		MMD-UP0211BHP-UL	021 type	21	21	24
		MMD-UP0241BHP-UL	024 type	24	24	27
		MMD-UP0301BHP-UL	030 type	30	30	34
		MMD-UP0361BHP-UL	036 type	36	36	40
High Static Duct		MMD-UP0421BHP-UL	042 type	42	42	47.5
		MMD-UP0481BHP-UL	048 type	48	48	54
		MMD-UP0541BHP-UL	054 type	54	54	60
		MMD-UP0241HP-UL	024 type	24	24	27
		MMD-UP0301HP-UL	030 type	30	30	34
Floor console exposed		MMD-UP0361HP-UL	036 type	36	36	40
		MMD-UP0481HP-UL	048 type	48	48	54
		MMD-UP0541HP-UL	054 type	54	54	60
		MML-UP0071H-UL	007 type	7.5	7.5	8.5
		MML-UP0091H-UL	009 type	9.5	9.5	10.5
Floor console recessed		MML-UP0121H-UL	012 type	12	12	13.5
		MML-UP0151H-UL	015 type	15.4	15.4	17
		MML-UP0181H-UL	018 type	18	18	20
		MML-UP0241H-UL	024 type	24	24	27
		MML-UP0071BH-UL	007 type	7.5	7.5	8.5
Floor console recessed		MML-UP0091BH-UL	009 type	9.5	9.5	10.5
		MML-UP0121BH-UL	012 type	12	12	13.5
		MML-UP0151BH-UL	015 type	15.4	15.4	17
		MML-UP0181BH-UL	018 type	18	18	20
Floor console recessed		MML-UP0241BH-UL	024 type	24	24	27

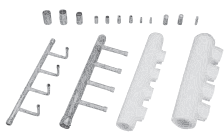
1-2-3. Branching joints and headers

Name	Model name	Appearance
Y-shape branching joint	RBM-BY55UL	
4-branching header	RBM-HY1043UL	
8-branching header	RBM-HY1083UL	

1-2-4. Remote control

Name	Model name	Remarks
Wired remote control	RBC-AMT32UL	
	RBC-AMS54E-UL	
	RBC-AWSU52-UL	
Simple wired remote control	RBC-AS41UL	
Wireless remote control kit	RBC-AX32U(W)-UL	For 4-Way Cassette type
	RBC-AXU31UP-UL	For 4-Way Cassette type
	RBC-AXU31UM-UL	For Compact 4-Way Cassette type
	RBC-AX33UYYP-UL	For Compact 1-Way Cassette type
	RBC-AX33C-UL	For Ceiling type
	RBC-AXU33CP-UL	For Ceiling type
	RBC-AX32-UL	For Compact 4-Way Cassette type, Medium Static Ducted type, Slim Ducted type, Floor console recessed type
	RBC-AXU31-UL	For All other units
Central remote control	BMS-CM1281TLUL	
	BMS-SC640U-UL	
Wired remote control with weekly timer	RBC-AMS41UL	

1-2-5. Optional PCB of outdoor unit

Name	Model name	Remarks
Power peak-cut control board	TCB-PCDM4UL	Power peak-cut control
External master ON/OFF control board	TCB-PCMO4UL	External master ON/OFF control, Night operation control, Operation mode selection control, Snowfall fan control
Output control board	TCB-PCIN4UL	Error / operation output control, Compressor operation output, Operating rate output

1-2-6. Controls

Name	Model name	Remarks
Remote location ON/OFF Control Box	TCB-IFCB-4UL	
"1:1 model" Connection Interface	TCB-PCNT31TLUL	Link adapter for "1:1 model" to enable connection to VRF system network.
LonWorks LN Interface	TCB-IFLN642TLUL	
Smart BMS manager	BMS-SM1280HTLUL	
Energy Monitoring Relay Interface	BMS-IFWH5UL	
Digital I/O Relay Interface	BMS-IFDD03UL	
BACnet Server	BMS-LSV6UL	
	BMS-STBN10UL	
Relay Interface	BMS-IFLSV4UL	
BN Interface	BMS-IFBN640TLUL	
Touch Screen Controller	BMS-CT5120UL	

"1:1 model" : RAV type indoor unit



2-1. Selection flow chart

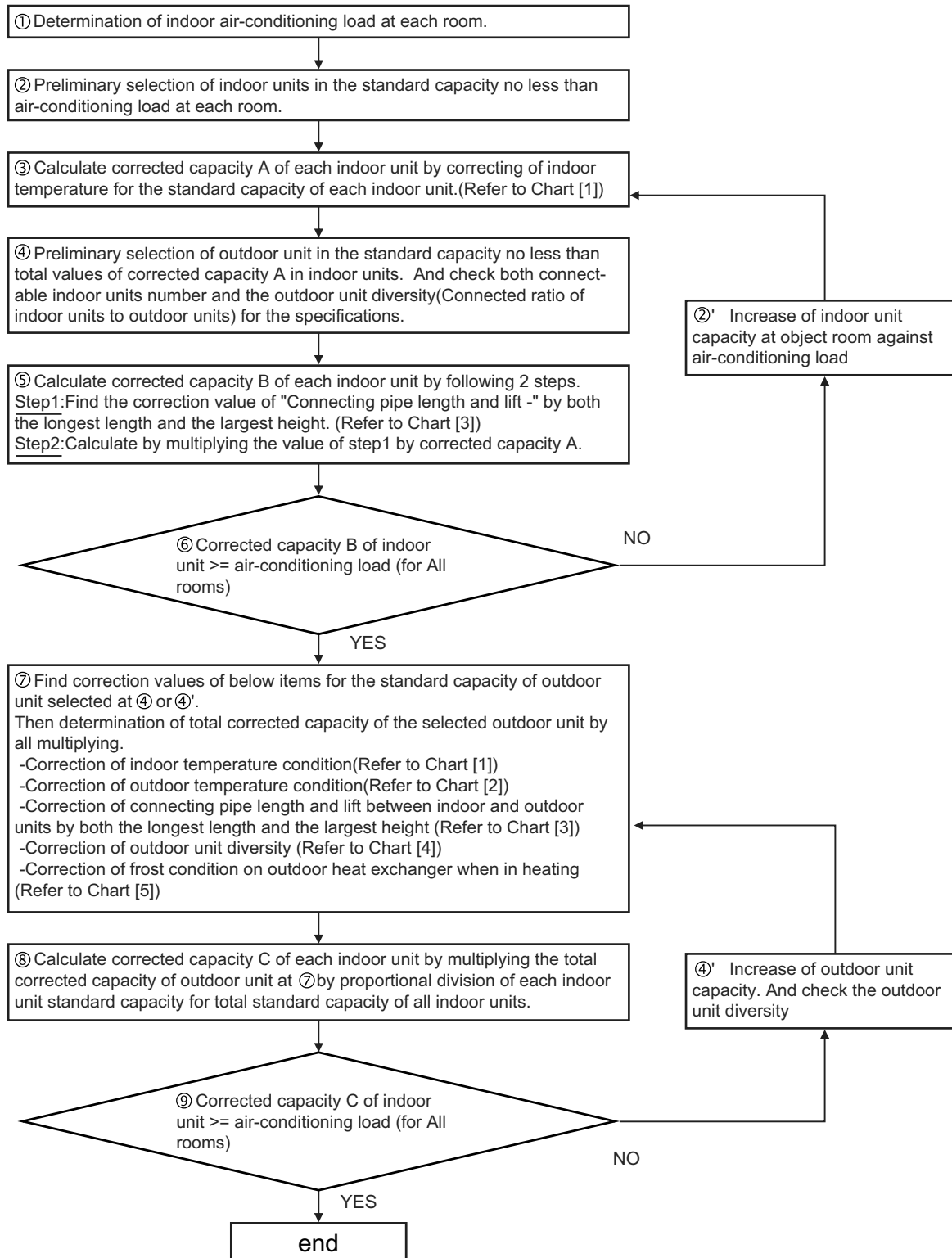

Note : Please use selection software to layout the system.



2-2. Combination conditions for indoor unit and outdoor unit

Indoor unit can connect 50% to 135% of Outdoor unit capacity.

*Permanent operation below 80% is not recommended.

2-2-1. The capacity code of indoor unit is decided for each capacity type.

Indoor unit capacity type	007	009	012	015	018	021	024	027	030	036	042	048	054
Indoor unit capacity code	7.5	9.5	12	15.4	18	21	24	27	30	36	42	48	54

2-2-2. For outdoor unit, maximum No. of connectable indoor units and total capacity code of indoor units are decided.

Outdoor unit	Capacity code of outdoor unit	No. of connectable indoor units	Total capacity code of indoor units
MCY-MAP0367HS-UL	36	2 to 6	18 to 48
MCY-MAP0487HS-UL	48	2 to 8	24 to 64
MCY-MAP0607HS-UL	60	2 to 9	30 to 81



2-3. Cooling/heating capacity characteristics

2-3-1. Correction charts for cooling capacity calculation

[Chart 1] Indoor air wet bulb temperature vs. capacity correction value



[Chart 2] Outdoor air dry bulb temperature vs. capacity correction value

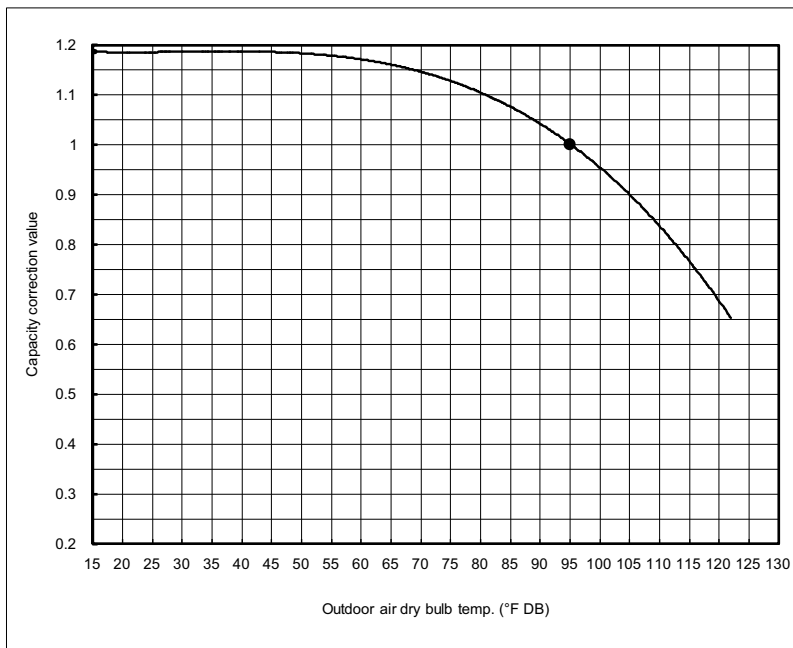



[Chart 3] Connecting pipe length and lift difference between indoor and outdoor units vs. capacity correction value

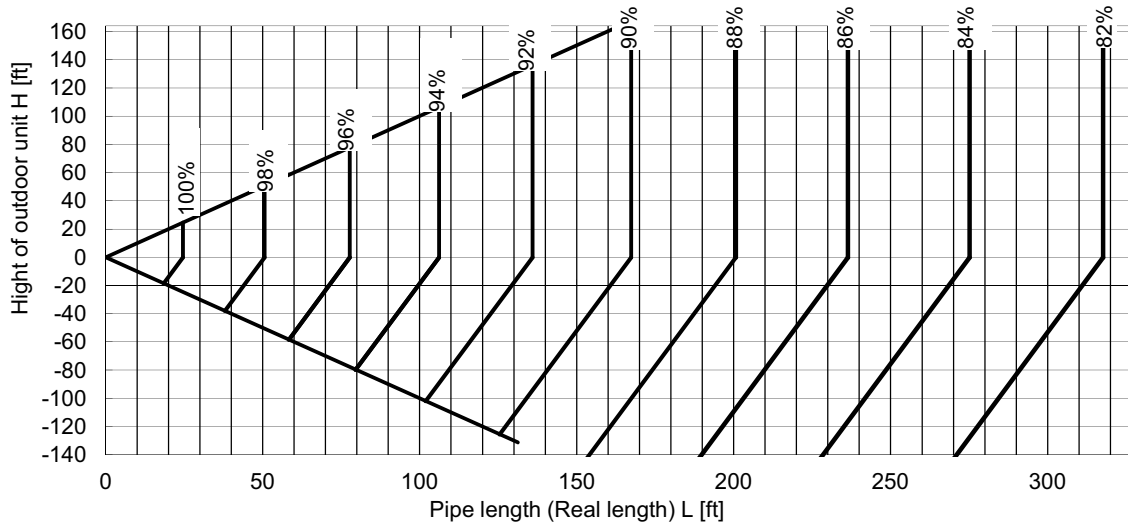
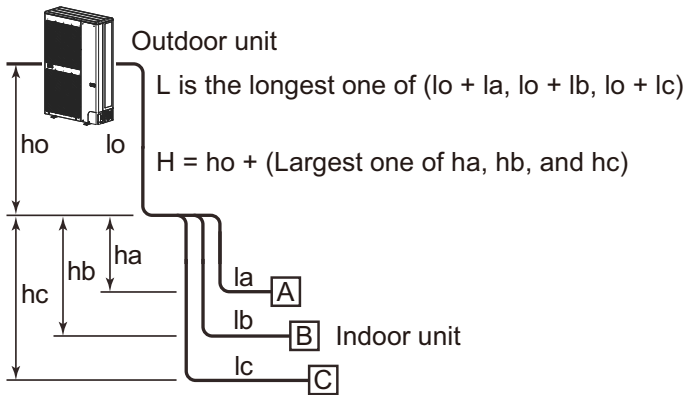



[4]* Correction of outdoor unit diversity

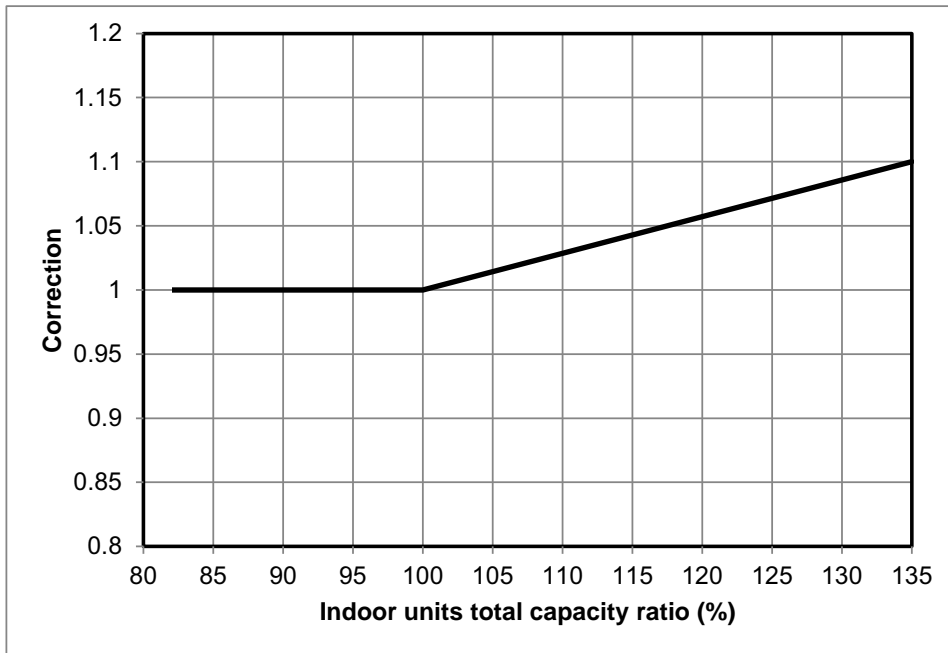

* Coefficient to use for the correction of the outdoor unit capacity when the total capacity of the indoor units are not equal to the outdoor unit capacity.



2-3-2. Correction charts for heating capacity calculation

[Chart 1] Indoor air dry bulb temperature vs. capacity correction value

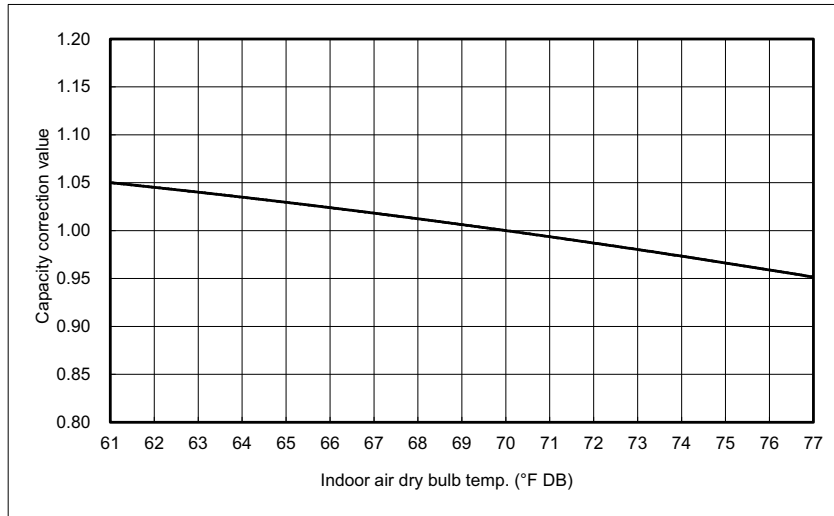

[Chart 2] Outdoor air wet bulb temperature vs. capacity correction value

MCY-MAP0367HS-UL

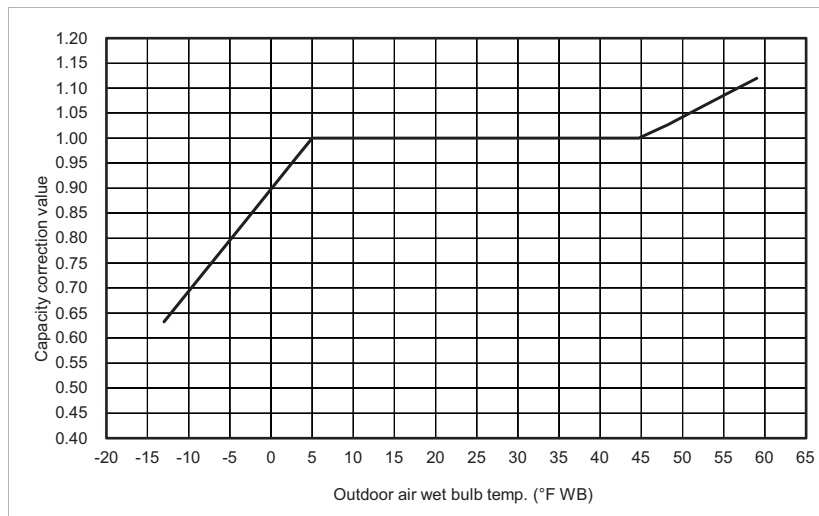

MCY-MAP0487HS-UL

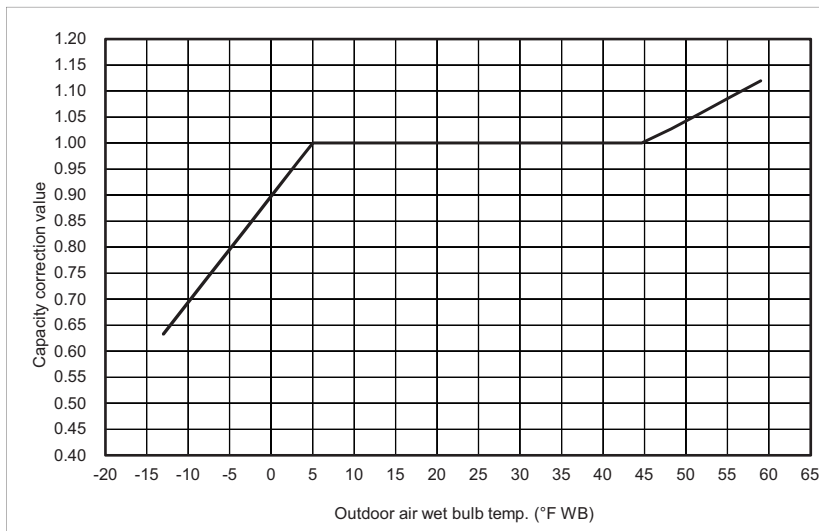



MCY-MAP0607HS-UL

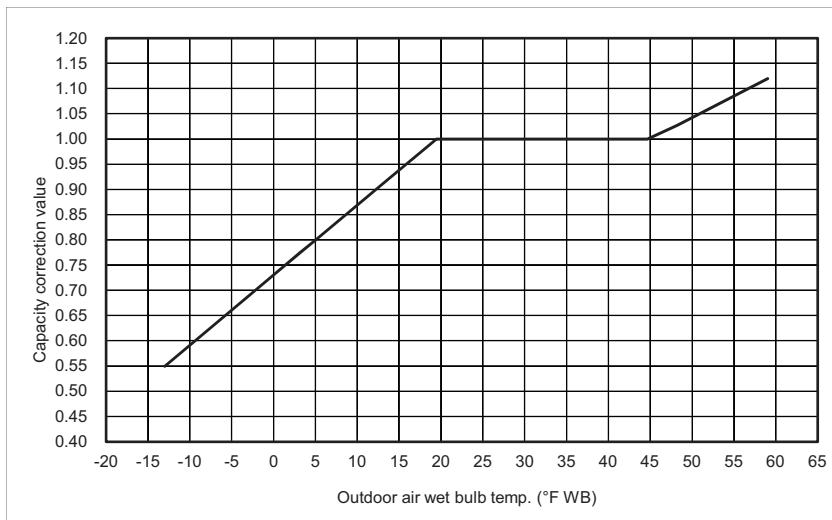

[Chart 3] Connecting pipe length and lift difference between indoor and outdoor units vs. capacity correction value

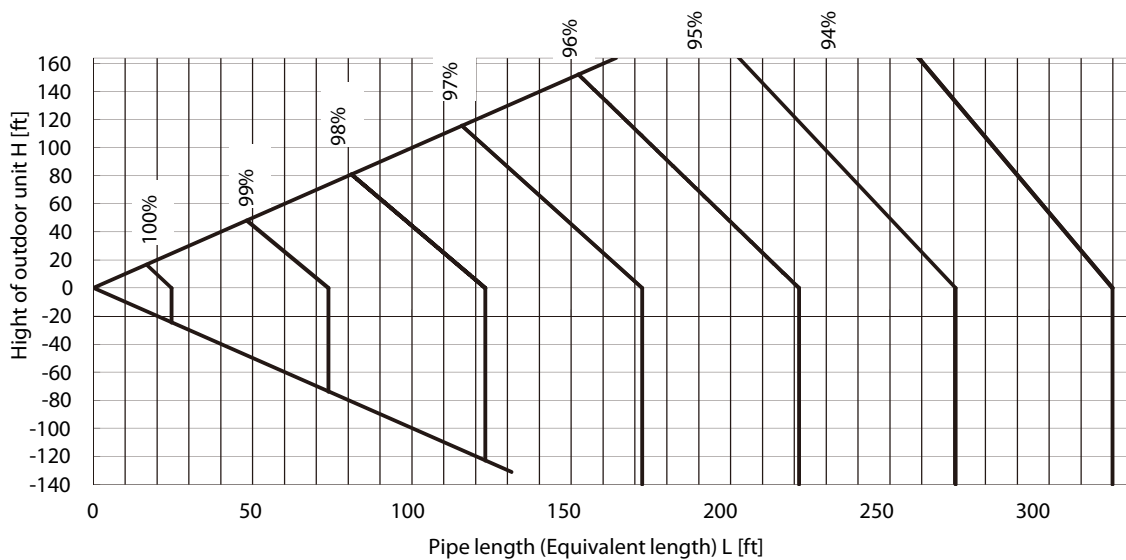
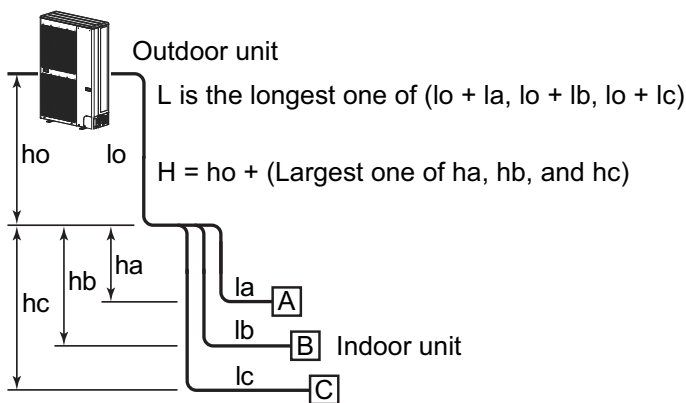



[Chart 4]* Correction of outdoor unit diversity

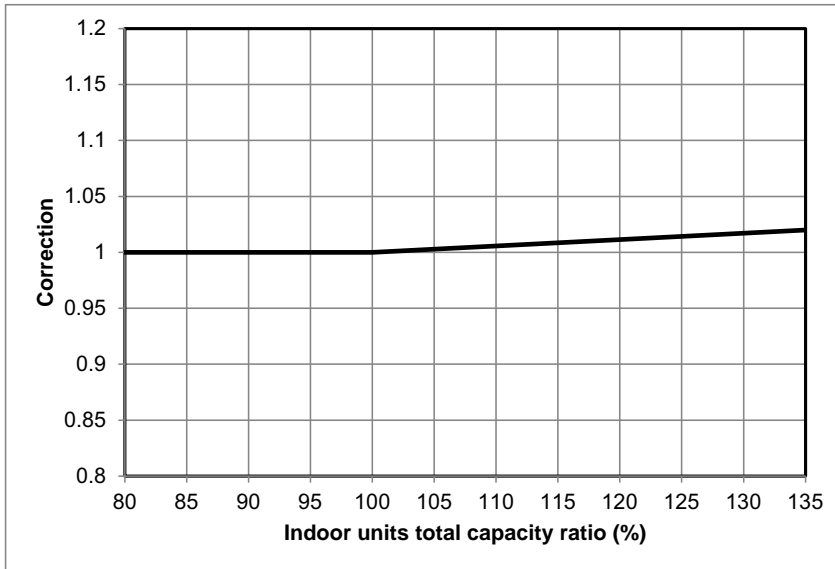

* Coefficient to use for correction of outdoor unit capacity when total capacity of the indoor units are not equal to the outdoor unit capacity.

2-3-3. Capacity correction in case of frost on the outdoor heat exchanger when in heating

Correct the heating capacity when frost can be found on the outdoor heat exchanger.

Heating capacity = Capacity after correction of outdoor unit x Correction value of capacity resulted from frost
 (Capacity after correction of outdoor unit: Heating capacity calculated in the above item 2.)

[Chart 5] Capacity correction in case of frost on the outdoor heat exchanger

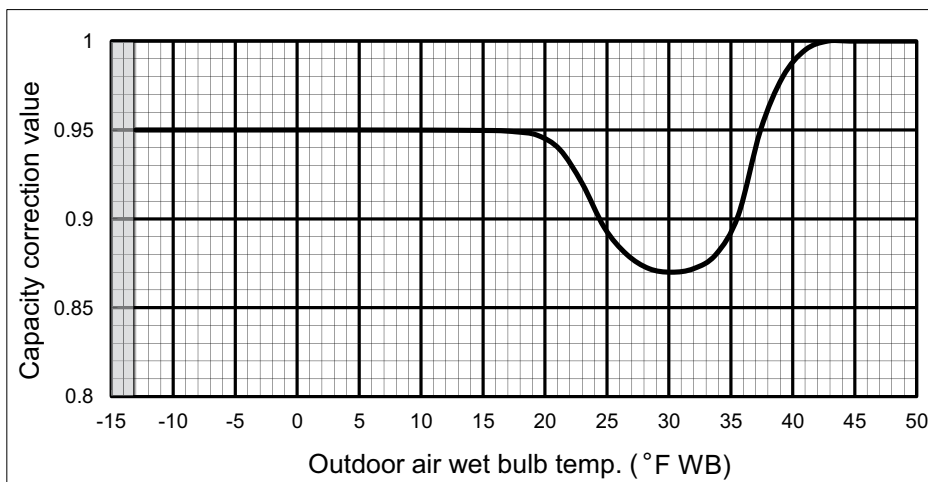

2-3-4. Rated conditions

Cooling: Indoor air temperature 80 °F DryBulb/67 °F WetBulb, Outdoor air temperature 95 °F DryBulb

Heating: Indoor air temperature 70 °F DryBulb, Outdoor air temperature 47 °F DryBulb/43 °F WetBulb



2-4. Operational temperature range

Cooling

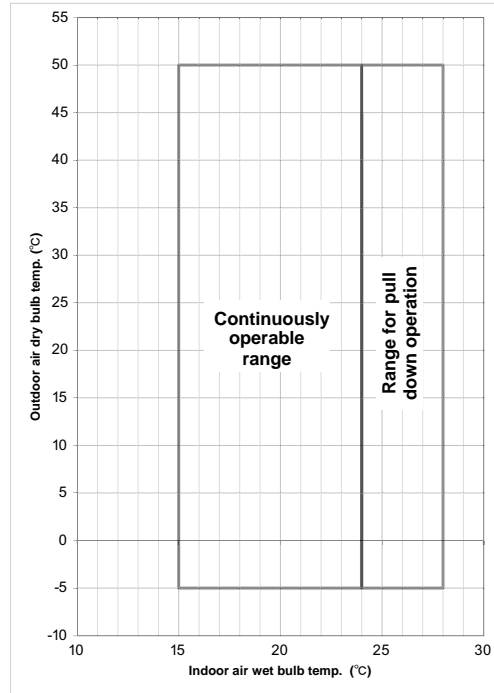
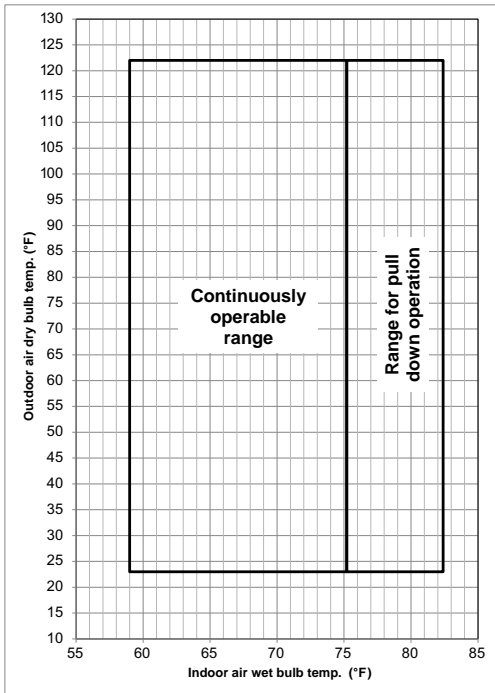

Heating

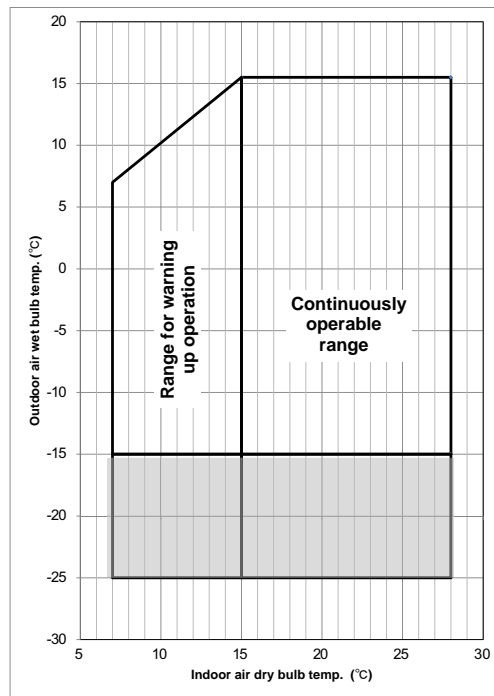
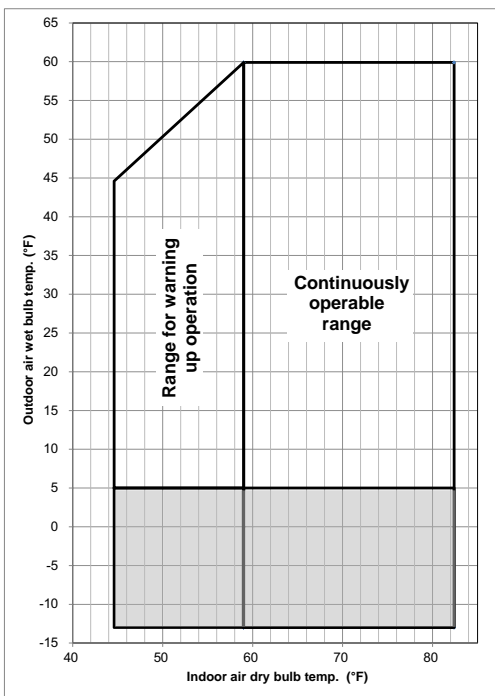

The unit will operate down to an outdoor temperature of -13°F, however considerable performance decrease will be expected below 5°F. Therefore please consider installation location/surroundings and system design when expected to operate between 5 °F and -13°F.



3-1. Free branching system

- [1] Line branching system
- [2] Header branching system
- [3] Header branching system after line branching
- [4] Line branching system after header branching
- [5] Header branching system after header branching

The above five branching systems enable to dramatically increase the flexibility of refrigerant piping design.

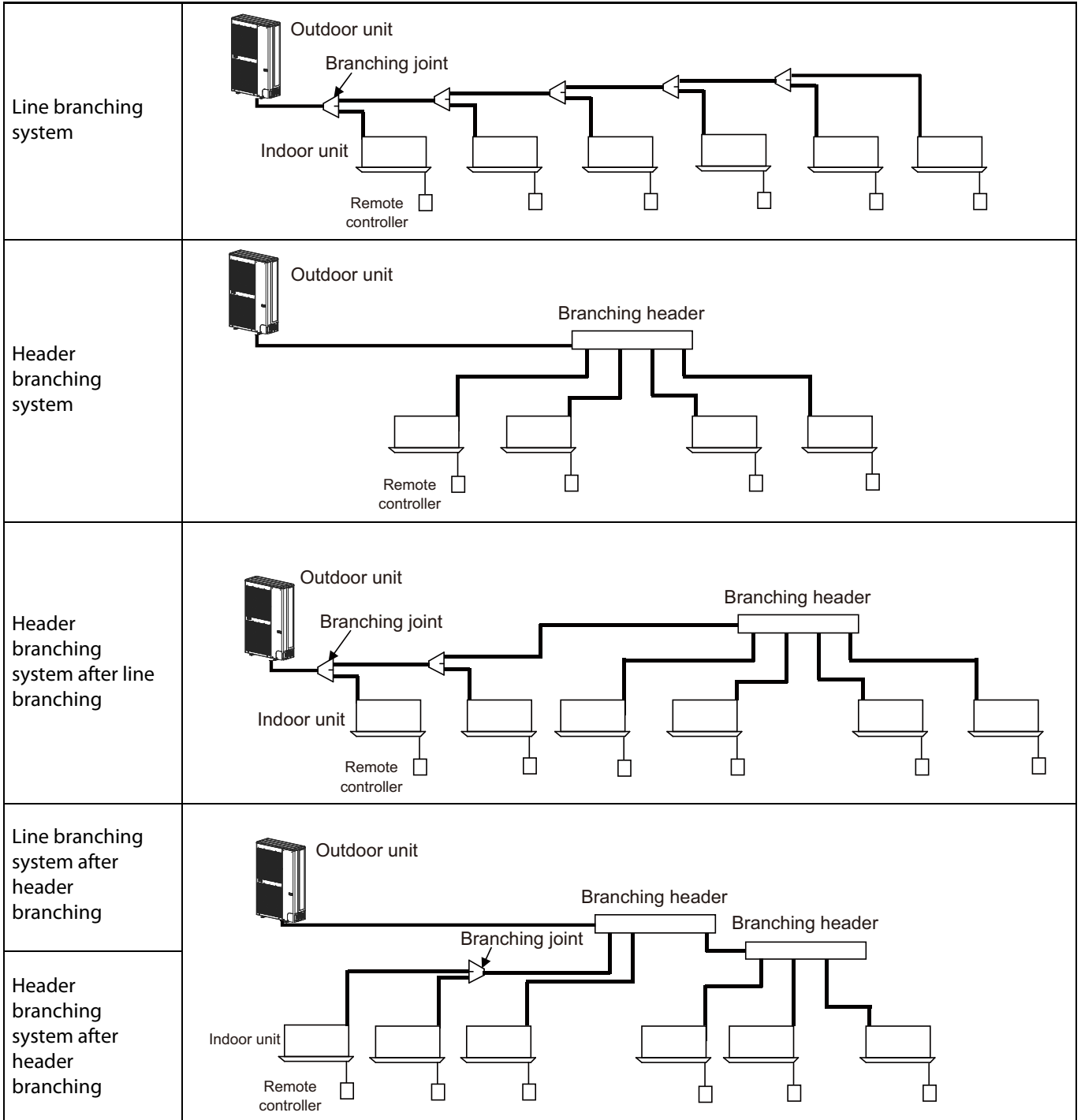



3-2. Allowable length/height difference of refrigerant piping

■ Allowable length / height difference of refrigerant piping

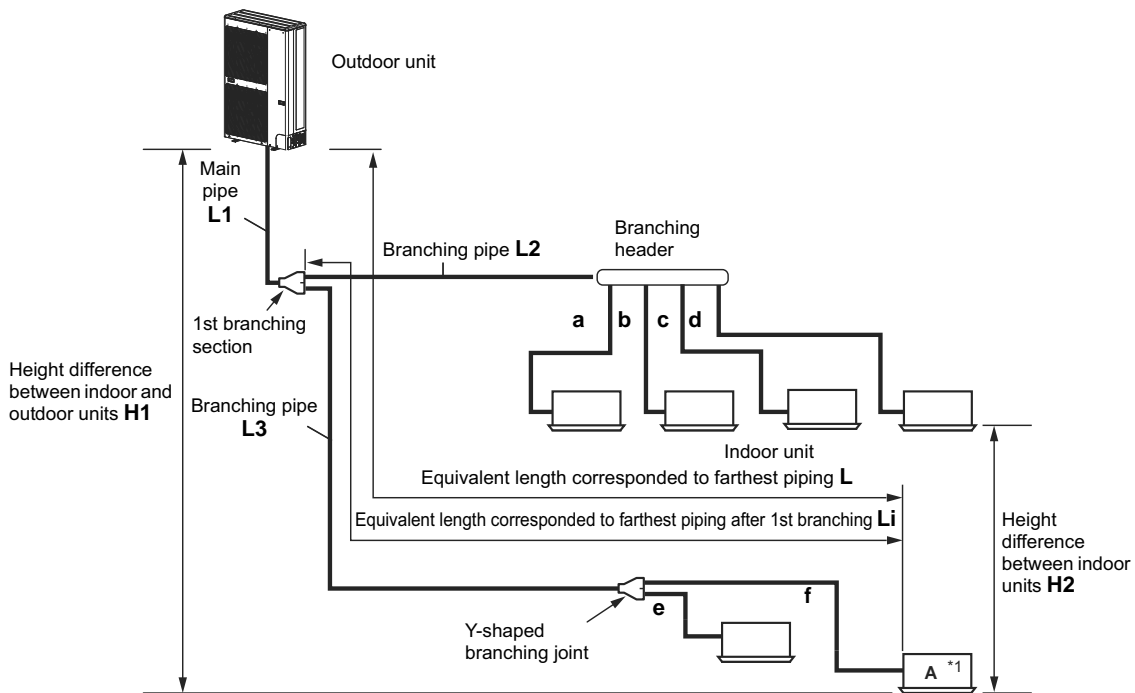

		Allowable value (ft (m))	Pipes
Piping Length	Total extension of pipe (liquid pipe, real length)	591 (180)	$L1 + L2 + L3 + a + b + c + d + e + f$
	Furthest piping length L (*1)	Real length	328 (100)
		Equivalent length	410 (125)
	Max. equivalent length of main pipe	213 (65)	L1
	Max. equivalent length of furthest piping from 1st branching Li (*1)	115 (35)	$L3 + f$
	Max. real length of indoor unit connecting pipe	49 (15) (*2)	a, b, c, d, e, f
Height Difference	Height between indoor and outdoor units H1	Upper outdoor unit	164 (50)
		Lower outdoor unit	131 (40)
	Height between indoor units H2	49 (15)	-

*1 Furthest indoor unit from 1st branch to be named "A".

*2 Max real length of indoor unit connecting pipe varies depending on H2. Please refer to the table below.

Max. real length of indoor unit connecting pipe	Allowable value (ft (m))		
	$H2 \leq 16\text{ft (5m)}$	$16\text{ft (5m)} < H2 \leq 33\text{ft (10m)}$	$33\text{ft (10m)} < H2$
	98ft (30m) (*3)	65ft (20m) (*3)	49ft (15m)

*3 Connecting pipe size of indoor unit varies depending on Max real length of indoor unit connecting pipe. See the page of "Selection of refrigerant piping" for details.



3-3. Selection of refrigerant piping

■ Selection of refrigerant piping

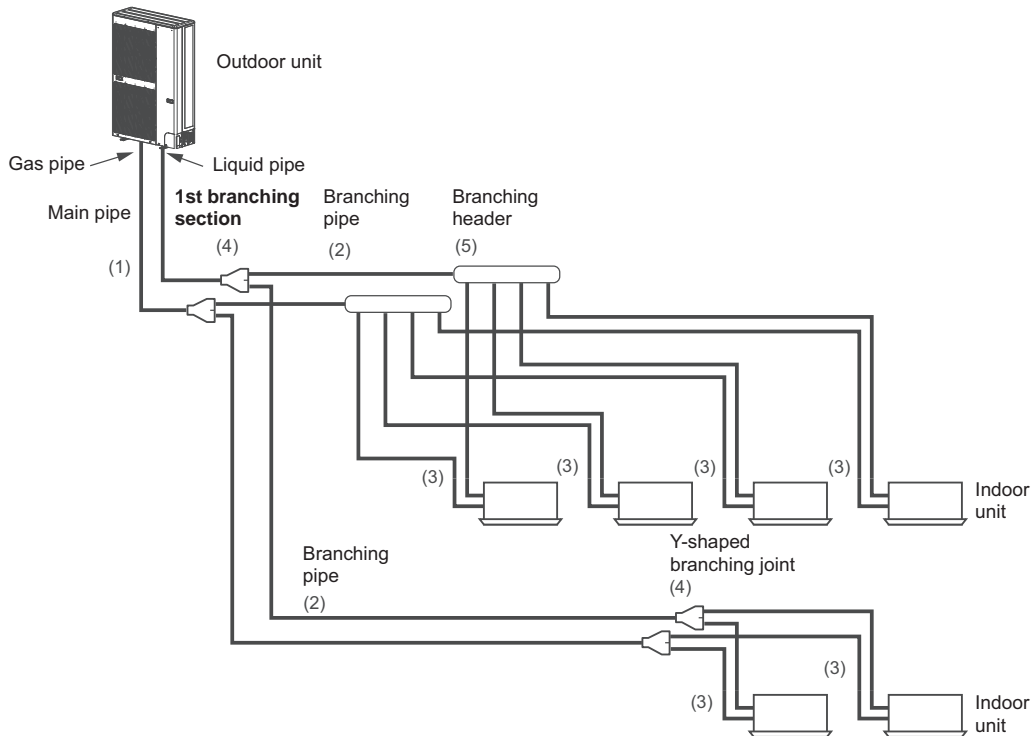

No.	Piping parts	Name	Selection of pipe size	Remarks		
(1)	Outdoor unit ↓ 1st branching section	Main pipe	Size of main pipe		Same as connecting pipe size of the outdoor unit.	
			Outdoor unit capacity type	Gas pipe		Liquid pipe
			0367 type	Ø5/8"		Ø3/8"
			0487 type	Ø5/8"		Ø3/8"
(2)	Branching section ↓ Branching section	Branching pipe	Pipe size between branching sections		Pipe size differs based on the total capacity code value of indoor units at the downstream side. If the total value exceeds the capacity code of the outdoor unit, apply the capacity code of the outdoor unit. (See Table 1 and 2.)	
			Total capacity codes of indoor units at down stream side	Gas pipe		Liquid pipe
			Equivalent to capacity			
			Below 23	Ø1/2"		Ø3/8"
			23 to below 61	Ø5/8"		Ø3/8"
61 or more	Ø3/4"	Ø3/8"				



(3)	Branching section ↓ Indoor unit	Indoor unit connecting pipe	Connecting pipe size of indoor unit				
			Capacity rank		Gas pipe	Liquid pipe	
			007 to 012 type	Pipe length (real length)	49ft (15m) or less	Ø3/8"	Ø1/4"
					More than 49ft (15m)	Ø1/2"	Ø1/4"
			015 to 018 type			Ø1/2"	Ø1/4"
021 to 054 type			Ø5/8"	Ø3/8"			
(4)	Branching section	Y-shaped branching joint	Selection of branching section (Y-shaped branching joint)				
					Model name		
			Y-shape branch joint				
(5)	Branching section	Branching header	Selection of branching section (Branching header)				
					Model name		
		Branching header*	For 4 branches	RBM-HY1043UL			
			For 8 branches	RBM-HY1083UL			
* A capacity code of up to a maximum of 57 is connectable to one line after branching from the header.							

3-4. Charging requirement with additional refrigerant

■ Adding refrigerant

After finishing vacuuming, exchange the vacuum pump with a refrigerant canister and start additional charging of refrigerant.

Calculation of additional refrigerant charge amount

Default refrigerant amount does not include the refrigerant for pipes at the local site.

For refrigerant to be charged in pipes at the local site, calculate the amount and charge it additionally.

Outdoor unit type	MAP0367	MAP0487	MAP0607
Charging amount (lbs (kg))	14.8 (6.7)	14.8 (6.7)	14.8 (6.7)

$$\text{Additional refrigerant charge amount at local site} = \text{Real length of liquid pipe} \times \text{Additional refrigerant charge amount per 1 ft liquid pipe (Table 1)} \times 1.2 + \text{Compensation by outdoor HP (Table 2)}$$

Table 1

Liquid pipe dia. (in)	Ø1/4"	Ø3/8"
Additional refrigerant amount / 1 m liquid pipe (lbs/ft)	0.017	0.038

Table 2

Outdoor unit type	MAP0367	MAP0487	MAP0607
Compensation by outdoor capacity (lbs (kg))	0 (0)	0.88 (0.4)	1.76 (0.8)

Example: (060 type)

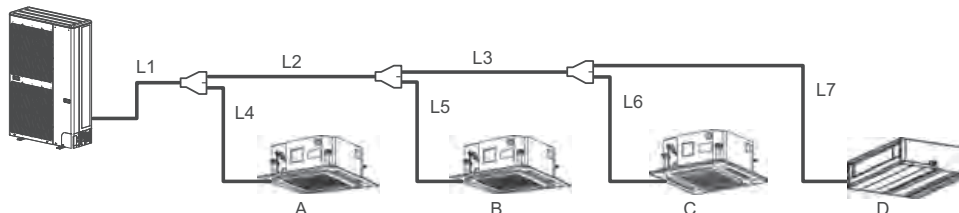

L1	Ø3/8": 32.8 ft	L2	Ø3/8": 32.8 ft	L3	Ø3/8": 16.4 ft	L4	Ø3/8": 9.8 ft
L5	Ø1/4": 9.8 ft	L6	Ø1/4": 13.1 ft	L7	Ø1/4": 16.4 ft		

Additional charge amount R (kg)

Lx: Real total length of liquid pipe diameter 1/4" (ft)

Ly: Real total length of liquid pipe diameter 3/8" (ft)

$$\begin{aligned}
 &= \{ (Lx \times 0.017 \text{ lbs/ft}) + (Ly \times 0.038 \text{ lbs/ft}) \} \times 1.2 + (1.76 \text{ lbs}) \\
 &= \{ (39.3 \times 0.017 \text{ lbs}) + (91.8 \times 0.038 \text{ lbs}) \} \times 1.2 + (1.76 \text{ lbs}) \\
 &= 6.75 \text{ lbs}
 \end{aligned}$$



4-1. General

- All field wiring insulation rating must comply with NEC and local codes.
- Do not connect 208/230 V power to the terminal blocks for control cables (U1, U2, U3, U4); otherwise, the unit may break down.
- Be sure that electric wiring does not come into contact with high-temperature parts of piping; otherwise, the coating of cables may melt and cause an accident.
- After connecting wires to the terminal block, take off the traps and fix the wires with cord clamps.
- Do not conduct power to indoor units until vacuuming of the refrigerant pipes has finished.
- For the wiring of power to indoor units and that between indoor and outdoor units, follow the instructions in the installation manual of each indoor unit.
- Prepare an exclusive power supply for the air conditioner.

4-2. Outdoor unit power supply

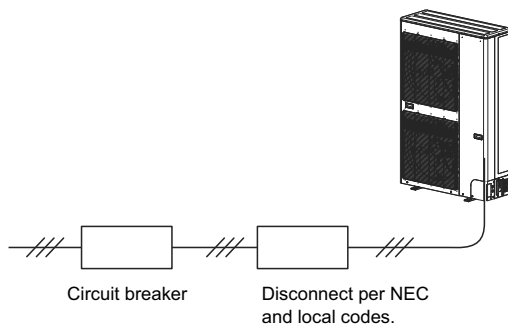

Outdoor unit data

Model name MCY-	Capacity type	Power supply		Voltage Range		Compressor (kW)	Fan Motor (kW)	MCA (A)	MOCP (A)	Recommended breaker size
		Phase and frequency	Nominal Voltage	Min. (V)	Max. (V)					
MAP0367HS-UL	36	1Ph 60 Hz	208/230 V	187	253	3.75	0.10 x 2	36.3	60	40
MAP0487HS-UL	48	1Ph 60 Hz	208/230 V	187	253	3.75	0.10 x 2	36.3	60	40
MAP0607HS-UL	60	1Ph 60 Hz	208/230 V	187	253	3.75	0.10 x 2	36.3	60	40



4-3. Indoor unit power supply

Type	Model name	Nominal Voltage (V-Ph-Hz)	Voltage Range (V)		FLA A	MCA A	MOCP A
			Min	Max			
4-Way Cassette	MMU-UP0071HP-UL	208/230-1-60	187	253	0.63	0.79	15
	MMU-UP0091HP-UL	208/230-1-60	187	253	0.63	0.79	15
	MMU-UP0121HP-UL	208/230-1-60	187	253	0.63	0.79	15
	MMU-UP0151HP-UL	208/230-1-60	187	253	0.80	1.00	15
	MMU-UP0181HP-UL	208/230-1-60	187	253	0.80	1.00	15
	MMU-UP0241HP-UL	208/230-1-60	187	253	0.87	1.09	15
	MMU-UP0301HP-UL	208/230-1-60	187	253	0.87	1.09	15
	MMU-UP0361HP-UL	208/230-1-60	187	253	1.15	1.44	15
Compact 4-Way Cassette	MMU-UP0071MH-UL	208/230-1-60	187	253	0.40	0.50	15
	MMU-UP0091MH-UL	208/230-1-60	187	253	0.40	0.50	15
	MMU-UP0121MH-UL	208/230-1-60	187	253	0.40	0.50	15
	MMU-UP0151MH-UL	208/230-1-60	187	253	0.50	0.60	15
	MMU-UP0181MH-UL	208/230-1-60	187	253	0.60	0.70	15
1-Way Cassette	MMU-UP0071YHP-UL	208/230-1-60	187	253	0.32	0.40	15
	MMU-UP0091YHP-UL	208/230-1-60	187	253	0.32	0.40	15
	MMU-UP0121YHP-UL	208/230-1-60	187	253	0.32	0.40	15
	MMU-UP0151YHP-UL	208/230-1-60	187	253	0.58	0.73	15
	MMU-UP0181YHP-UL	208/230-1-60	187	253	0.58	0.73	15
Ceiling	MMU-UP0241YHP-UL	208/230-1-60	187	253	0.80	1.00	15
	MMC-UP0181HP-UL	208/230-1-60	187	253	0.42	0.53	15
	MMC-UP0241HP-UL	208/230-1-60	187	253	0.75	0.93	15
	MMC-UP0301HP-UL	208/230-1-60	187	253	0.75	0.93	15
High Wall	MMC-UP0361HP-UL	208/230-1-60	187	253	0.89	1.11	15
	MMC-UP0481HP-UL	208/230-1-60	187	253	0.89	1.11	15
	MMK-UP0071HP-UL	208/230-1-60	187	253	0.17	0.21	15
	MMK-UP0091HP-UL	208/230-1-60	187	253	0.18	0.23	15
	MMK-UP0121HP-UL	208/230-1-60	187	253	0.20	0.25	15
	MMK-UP0151HP-UL	208/230-1-60	187	253	0.30	0.37	15
	MMK-UP0181HP-UL	208/230-1-60	187	253	0.33	0.42	15
Slim Duct	MMK-UP0241HP-UL	208/230-1-60	187	253	0.48	0.60	15
	MMK-UP0301HP-UL	208/230-1-60	187	253	0.66	0.83	15
	MMK-UP0361HP-UL	208/230-1-60	187	253	0.66	0.83	15
	MMD-UP0071SPH-UL	208/230-1-60	187	253	0.70	0.90	15
	MMD-UP0091SPH-UL	208/230-1-60	187	253	0.80	1.00	15
Medium Static Duct	MMD-UP0121SPH-UL	208/230-1-60	187	253	0.80	1.00	15
	MMD-UP0151SPH-UL	208/230-1-60	187	253	0.80	1.00	15
	MMD-UP0181SPH-UL	208/230-1-60	187	253	0.90	1.20	15
	MMD-UP0071BHP-UL	208/230-1-60	187	253	0.73	0.91	15
	MMD-UP0091BHP-UL	208/230-1-60	187	253	0.88	1.10	15
	MMD-UP0121BHP-UL	208/230-1-60	187	253	0.88	1.10	15
	MMD-UP0151BHP-UL	208/230-1-60	187	253	1.53	1.91	15
	MMD-UP0181BHP-UL	208/230-1-60	187	253	1.53	1.91	15
	MMD-UP0211BHP-UL	208/230-1-60	187	253	1.78	2.23	15
	MMD-UP0241BHP-UL	208/230-1-60	187	253	1.78	2.23	15
	MMD-UP0301BHP-UL	208/230-1-60	187	253	1.85	2.31	15
High Static Duct	MMD-UP0361BHP-UL	208/230-1-60	187	253	2.71	3.39	15
	MMD-UP0421BHP-UL	208/230-1-60	187	253	2.71	3.39	15
	MMD-UP0481BHP-UL	208/230-1-60	187	253	2.85	3.56	15
	MMD-UP0541BHP-UL	208/230-1-60	187	253	2.85	3.56	15
	MMD-UP0241HP-UL	208/230-1-60	187	253	2.07	2.59	15
Floor console exposed	MMD-UP0301HP-UL	208/230-1-60	187	253	2.39	2.99	15
	MMD-UP0361HP-UL	208/230-1-60	187	253	2.75	3.44	15
	MMD-UP0481HP-UL	208/230-1-60	187	253	3.10	3.88	15
	MMD-UP0541HP-UL	208/230-1-60	187	253	3.46	4.33	15
	MML-UP0071H-UL	208/230-1-60	187	253	0.30	0.40	15
	MML-UP0091H-UL	208/230-1-60	187	253	0.30	0.40	15
Floor console recessed	MML-UP0121H-UL	208/230-1-60	187	253	0.50	0.60	15
	MML-UP0151H-UL	208/230-1-60	187	253	0.50	0.60	15
	MML-UP0181H-UL	208/230-1-60	187	253	0.60	0.70	15
	MML-UP0241H-UL	208/230-1-60	187	253	0.60	0.70	15
	MML-UP0071BH-UL	208/230-1-60	187	253	0.30	0.40	15
Floor console recessed	MML-UP0091BH-UL	208/230-1-60	187	253	0.30	0.40	15
	MML-UP0121BH-UL	208/230-1-60	187	253	0.30	0.40	15
	MML-UP0151BH-UL	208/230-1-60	187	253	0.60	0.60	15
	MML-UP0181BH-UL	208/230-1-60	187	253	0.60	0.60	15
Floor console recessed	MML-UP0241BH-UL	208/230-1-60	187	253	0.60	0.70	15

MCA: Minimum Circuit Amps @208V
MOCP: Maximum Overcurrent Protection (Amps)

FLA: Full Load Amps @208V

4-4.Design of control wiring

• Summary of control wiring

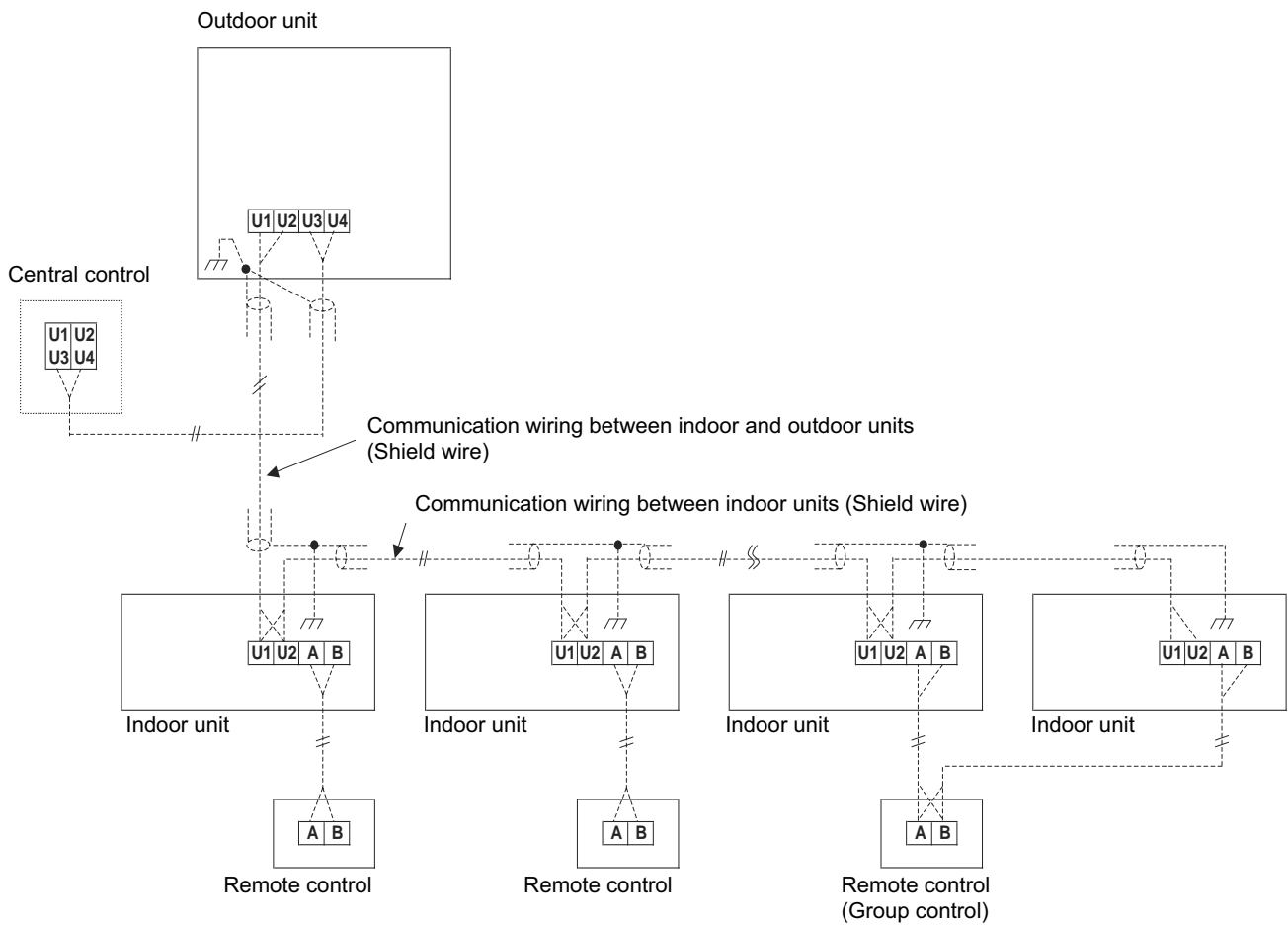

Communication wiring and central control wiring use 2-core non-polarity wires.

Use 2-core shield wires to prevent noise trouble.

In this case, for the system grounding, close (connect) the end of shield wires, and isolate the end of terminal.

Use 2-core non-polarity wire for remote control. (A, B terminals)

Use 2-core non-polarity wire for wiring of group control. (A, B terminals)

Keep the rule of below tables about size and length of communication wiring.

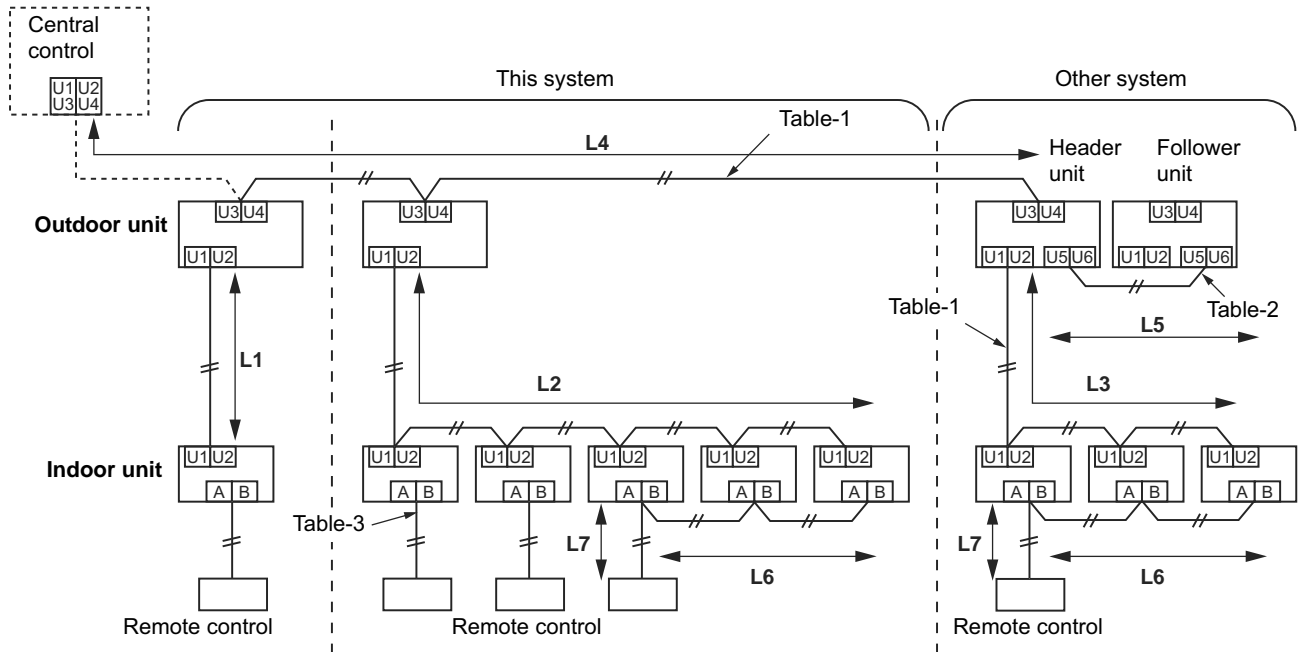

Table-1 Control wiring between indoor and outdoor units (L1, L2, L3), Central control wiring (L4)

Wiring	2-core, non-polarity
Type	Shield wire
Size / Length *1	AWG16: Up to 3280 ft (1000 m) AWG14: Up to 6560 ft (2000 m) (*1)

*1 Total of control wiring length for all refrigerant circuits (L1 + L2 + L3 + L4)

Table-2 Control wiring between outdoor units (L5) (Other system)

Wiring	2-core, non-polarity
Type	Shield wire
Size / Length	AWG16 to AWG14 / Up to 330 ft (100 m) (L5)

Table-3 Remote control wiring (L6, L7)

Wiring	2-core
Size	AWG20 to AWG14
Length	<ul style="list-style-type: none"> Up to 1640 ft (500 m) (L6 + L7) Up to 1310 ft (400 m) in case of wireless remote control in group control. Up to 660 ft (200 m) total length of control wiring between indoor units (L6)

Group control through a remote control

Group control of multiple indoor units (8 units) through a single remote control

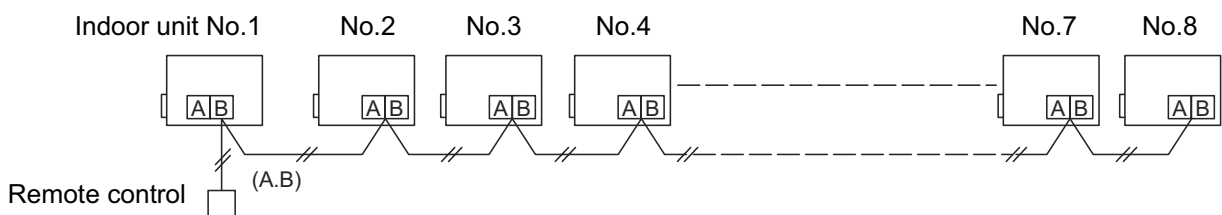



5-1. Specifications

System with Non-ducted indoor units

Outdoor unit model name				MCY-MAP0367HS-UL	MCY-MAP0487HS-UL	MCY-MAP0607HS-UL		
Outdoor unit type				Inverter	Inverter	Inverter		
Capacity code			ton	3	4	5		
Cooling Capacity			(*1) Btu/h	36,000	48,000	60,000		
Heating Capacity			(*1) Btu/h	40,000	54,000	66,000		
Electrical characteristics	Non-ducted	Power supply		(*2) Single phase 60Hz 208/230V	Single phase 60Hz 208/230V	Single phase 60Hz 208/230V		
		Cooling (*1)	Running current	A	12.17	16.41	21.41	
			Power consumption	kW	2.52	3.64	4.88	
			EER2		14.30	13.20	12.30	
		Heating (*1)	Running current	A	12.15	17.43	21.18	
			Power consumption	kW	2.60	3.86	4.83	
			COP2		4.50	4.10	4.00	
		COP2 (17F) (*3)			3.00	2.60	2.50	
		COP2 (5F) (*4)			3.00	2.60	2.40	
		SEER2			22.80	22.60	23.10	
HSPF2			10.00	10.30	10.60			
Starting Current		A	Soft start	Soft start	Soft start			
Dimension	Unit	Height	In	61.0	61.0	61.0		
		Width	In	39.8	39.8	39.8		
		Depth	In	14.6	14.6	14.6		
	Packing	Height	In	66.5	66.5	66.5		
		Width	In	43.2	43.2	43.2		
		Depth	In	20.3	20.3	20.3		
Total Weight	Unit	lbs	311	311	311			
	Packed unit	lbs	331	331	331			
Appearance(Color)				Silky shade (Munsell 1Y8.5/0.5)	Silky shade (Munsell 1Y8.5/0.5)	Silky shade (Munsell 1Y8.5/0.5)		
Compressor	Type			Hermetic twin rotary compressor	Hermetic twin rotary compressor	Hermetic twin rotary compressor		
	Motor output			kW	3.75	3.75	3.75	
Fan unit	Fan			Propeller fan (Quantity 2)	Propeller fan (Quantity 2)	Propeller fan (Quantity 2)		
	Motor output			W	100+100	100+100	100+100	
	Air volume			cfm	4520	4690	4850	
Heat exchanger				Finned tube	Finned tube	Finned tube		
Refrigerant R410A(Charged refrigerant amount(lbs))				(*5) 14.8	14.8	14.8		
High-pressure switch				psi	ON:602, OFF:464	ON:602, OFF:464	ON:602, OFF:464	
Protective devices				Discharge temp. sensor / Suction temp. sensor / High-pressure sensor		Discharge temp. sensor / Suction temp. sensor / High-pressure sensor	Discharge temp. sensor / Suction temp. sensor / High-pressure sensor	
				Low-pressure sensor / Compressor case thermostat / PC board fuse		Low-pressure sensor / Compressor case thermostat / PC board fuse	Low-pressure sensor / Compressor case thermostat / PC board fuse	
Electrical specifications	Unit	MCA (*6)	A	36.3	36.3	36.3		
		MOCP (*7)	A	60	60	60		
		Recommended breaker size	A	40	40	40		
Refrigerant piping	Connecting port dia	Gas side(main pipe)	In	φ5/8	φ5/8	φ3/4		
		Liquid side(main pipe)	In	φ3/8	φ3/8	φ3/8		
	Connecting method	Gas side		Flare	Flare	Flare		
		Liquid side		Flare	Flare	Flare		
Max. No. of connected indoor units				6	8	9		
Sound pressure level				Cooling	dB(A)	52	54	55
				Heating	dB(A)	55	57	58
Operation temperature range				Cooling	FDB	23 to 122	23 to 122	23 to 122
				Heating	FWB	-13 to 60	-13 to 60	-13 to 60

- (*1) Rated conditions Cooling : Indoor 80 F Dry Bulb /67 F Wet Bulb , Outdoor 95 F Dry Bulb.
Heating : Indoor 70 F Dry Bulb, Outdoor 47 F Dry Bulb / 43 F WetBulb.
- (*2) The standard pipe means that equivalent piping length of 25ft and standard 0ft piping height difference .
- (*3) The source voltage must not fluctuate more than ±10%
- (*4) Heating conditons: Indoor 70 F Dry Bulb, Outdoor 17 F Dry Bulb / 15 F Wet Bulb.
The standard pipe means that equivalent piping length of 25ft and standard 0ft piping height defference.
- (*5) Heating conditons: Indoor 70 F Dry Bulb, Outdoor 5 F Dry Bulb / 3 F Wet Bulb.
The standard pipe means that equivalent piping length of 25ft and standard 0ft piping height defference.
- (*6) The amount dose not consider extra piping length and indoor unit type.
Refrigerant must be added on site in accordance with the actual piping length and indoor unit type
- (*7) Select wire size base on the larger value of MCA.
MOCP:Maximum overcurrent protection (Amps)



**Standard model
System with Ducted indoor units**

Outdoor unit model name				MCY-MAP0367HS-UL	MCY-MAP0487HS-UL	MCY-MAP0607HS-UL	
Outdoor unit type				Inverter	Inverter	Inverter	
Capacity code			ton	3	4	5	
Cooling Capacity			(*1) Btu/h	36,000	48,000	60,000	
Heating Capacity			(*1) Btu/h	40,000	54,000	66,000	
Electrical characteristics	Ducted	Power supply		(*2)	Single phase 60Hz 208/230V	Single phase 60Hz 208/230V	Single phase 60Hz 208/230V
		Cooling (*1)	Running current	A	12.75	16.94	23.80
			Power consumption	kW	2.98	4.10	5.83
			EER2		12.10	11.70	10.30
		Heating (*1)	Running current	A	11.85	17.03	21.74
			Power consumption	kW	2.93	4.16	5.37
			COP2		4.00	3.80	3.60
		COP2 (17F) (*3)			2.70	2.50	2.30
		COP2 (5F) (*4)			2.70	2.50	2.20
		SEER2			20.10	17.90	18.40
HSPF2			10.90	10.00	9.80		
Starting Current		A	Soft start	Soft start	Soft start		
Dimension	Unit	Height	In	61.0	61.0	61.0	
		Width	In	39.8	39.8	39.8	
		Depth	In	14.6	14.6	14.6	
	Packing	Height	In	66.5	66.5	66.5	
		Width	In	43.2	43.2	43.2	
		Depth	In	20.3	20.3	20.3	
Total Weight	Unit	lbs	311	311	311		
	Packed unit	lbs	331	331	331		
Appearance(Color)				Silky shade (Munsell 1Y8.5/0.5)	Silky shade (Munsell 1Y8.5/0.5)	Silky shade (Munsell 1Y8.5/0.5)	
Compressor	Type			Hermetic twin rotary compressor	Hermetic twin rotary compressor	Hermetic twin rotary compressor	
	Motor output	kW		3.75	3.75	3.75	
Fan unit	Fan			Propeller fan (Quantity 2)	Propeller fan (Quantity 2)	Propeller fan (Quantity 2)	
	Motor output	W		100+100	100+100	100+100	
	Air volume	cfm		4520	4690	4850	
Heat exchanger				Finned tube	Finned tube	Finned tube	
Refrigerant R410A(Charged refrigerant amount(lbs))				(*5)	14.8	14.8	14.8
High-pressure switch				psi	ON:602, OFF:464	ON:602, OFF:464	ON:602, OFF:464
Protective devices				Discharge temp. sensor / Suction temp. sensor / High-pressure sensor		Discharge temp. sensor / Suction temp. sensor / High-pressure sensor	Discharge temp. sensor / Suction temp. sensor / High-pressure sensor
				Low-pressure sensor / Compressor case thermostat / PC board fuse		Low-pressure sensor / Compressor case thermostat / PC board fuse	Low-pressure sensor / Compressor case thermostat / PC board fuse
Electrical specifications	Unit	MCA (*6)	A	36.3	36.3	36.3	
		MOCP (*7)	A	60	60	60	
		Recommended breaker size	A	40	40	40	
Refrigerant piping	Connecting port dia	Gas side(main pipe)	In	φ5/8	φ5/8	φ3/4	
		Liquid side(main pipe)	In	φ3/8	φ3/8	φ3/8	
	Connecting method	Gas side		Flare	Flare	Flare	
		Liquid side		Flare	Flare	Flare	
Max. No. of connected indoor units					6	8	9
Sound pressure level			Cooling	dB(A)	52	54	55
			Heating	dB(A)	55	57	58
Operation temperature range			Cooling	FDB	23 to 122	23 to 122	23 to 122
			Heating	FWB	-13 to 60	-13 to 60	-13 to 60

- (*1) Rated conditions Cooling : Indoor 80 F Dry Bulb /67 F Wet Bulb , Outdoor 95 F Dry Bulb.
Heating : Indoor 70 F Dry Bulb, Outdoor 47 F Dry Bulb / 43 F WetBulb.
- (*2) The standard pipe means that equivalent piping length of 25ft and standard 0ft piping height difference .
- (*3) The source voltage must not fluctuate more than ±10%
Heating conditons: Indoor 70 F Dry Bulb, Outdoor 17 F Dry Bulb / 15 F Wet Bulb.
- (*4) The standard pipe means that equivalent piping length of 25ft and standard 0ft piping height defference.
Heating conditons: Indoor 70 F Dry Bulb, Outdoor 5 F Dry Bulb / 3 F Wet Bulb.
- (*5) The standard pipe means that equivalent piping length of 25ft and standard 0ft piping height defference.
- (*6) The amount dose not consider extra piping length and indoor unit type.
Refrigerant must be added on site in accordance with the actual piping length and indoor unit type
- (*7) Select wire size base on the larger value of MCA.
MOCP:Maximum overcurrent protection (Amps)



5-3. Center of gravity

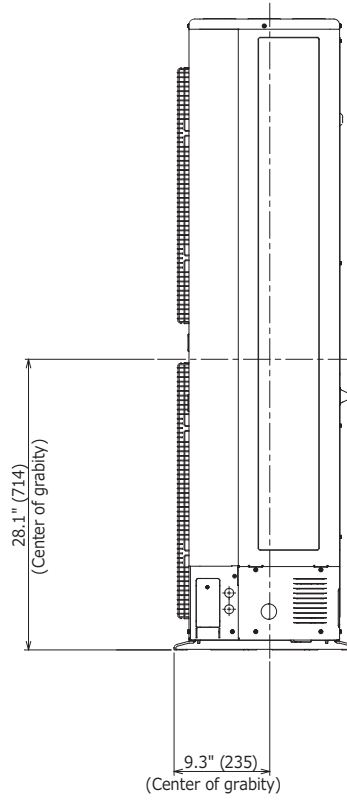
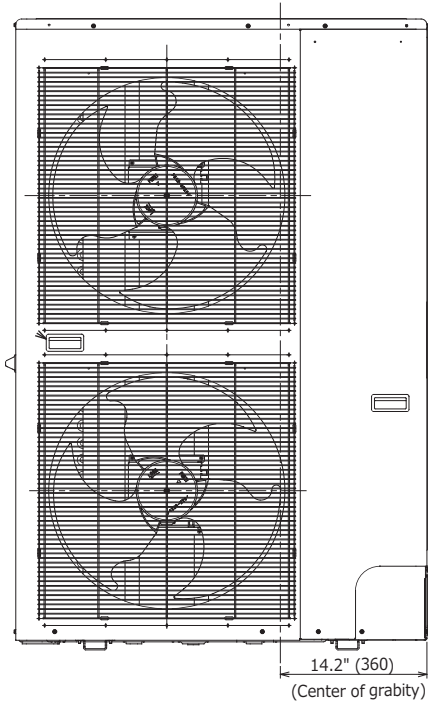

5-4. Branch header / Branch joint

- Branch header (Heat pump)
RBM-HY1043UL, HY1083UL

Gas side

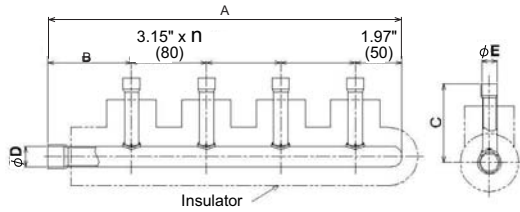

Liquid side

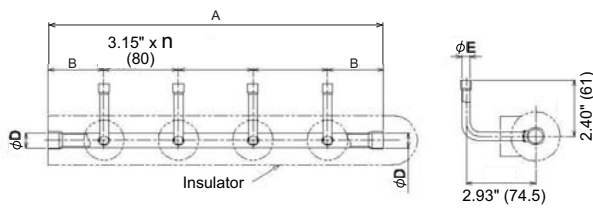

Unit: in (mm)

Model		A	B	C	D	E	n	Accessory socket Qty
RBM-HY1043UL	Gas side	15.0" (380)	3.54" (90)	3.29" (83.6)	7/8" (22.2)	5/8" (15.9)	3	⑥ × 4, ⑨ × 4, ⑭ × 1, ⑱ × 1, ⑳ × 1
	Liquid side	13.0" (330)	1.77" (45)	—	5/8" (15.9)	3/8" (9.5)	3	① × 4, ⑥ × 1, ⑨ × 1
RBM-HY1083UL	Gas side	27.6" (700)	3.54" (90)	3.29" (83.6)	7/8" (22.2)	5/8" (15.9)	7	⑥ × 8, ⑨ × 8, ⑭ × 1, ⑱ × 1, ⑳ × 1
	Liquid side	25.6" (650)	1.77" (45)	—	5/8" (15.9)	3/8" (9.5)	7	① × 8, ⑥ × 1, ⑨ × 1

- Y-shape branch joint (Heat pump)
RBM-BY55UL, BY105UL

Gas side

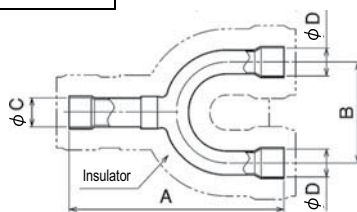

Liquid side

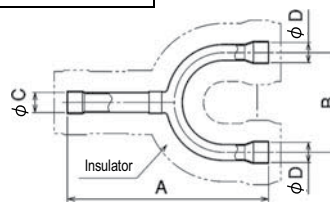

Unit: in (mm)

RBM-		A	B	C	D	Accessory socket Qty
BY55UL	Gas side	6.30" (160)	3.15" (80)	5/8" (15.9)	5/8" (15.9)	⑨ × 1, ⑩ × 2, ⑪ × 1
	Liquid side	5.12" (130)	2.76" (70)	3/8" (9.5)	3/8" (9.5)	① × 2
BY105UL	Gas side	6.69" (170)	3.15" (80)	7/8" (22.2)	7/8" (22.2)	⑫ × 21, ⑬ × 2, ⑭ × 1
	Liquid side	6.30" (160)	3.15" (80)	5/8" (15.9)	5/8" (15.9)	⑨ × 1, ⑩ × 1, ⑪ × 1

5-5. Refrigerant cycle diagram

Model : MCY-MAP0367HS-UL, MCY-MAP0487HS-UL, MCY-MAP0607HS-UL

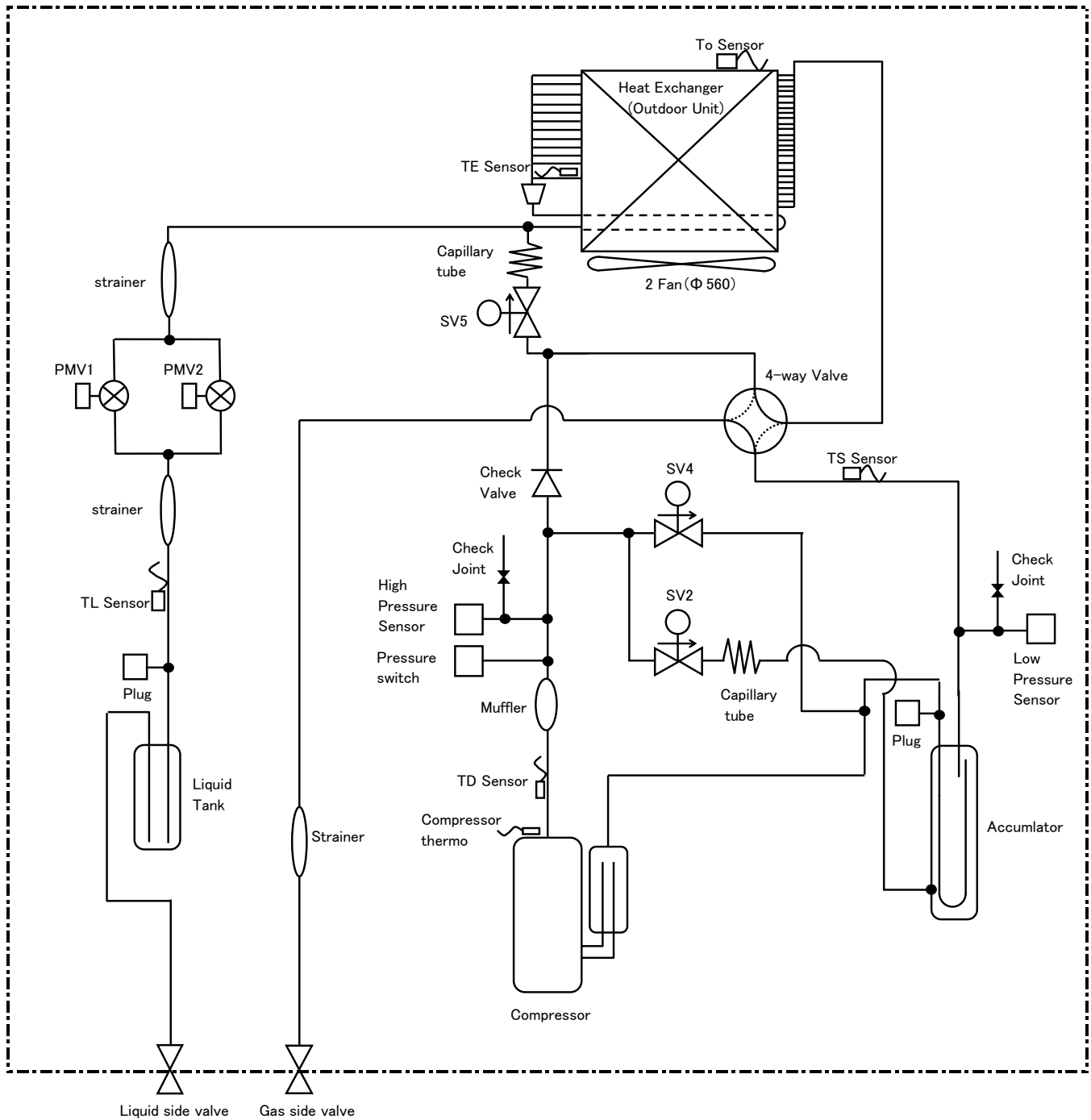



5-6. Wiring diagram

Model : MCY-MAP0367HS-UL, MCY-MAP0487HS-UL, MCY-MAP00607HS-UL

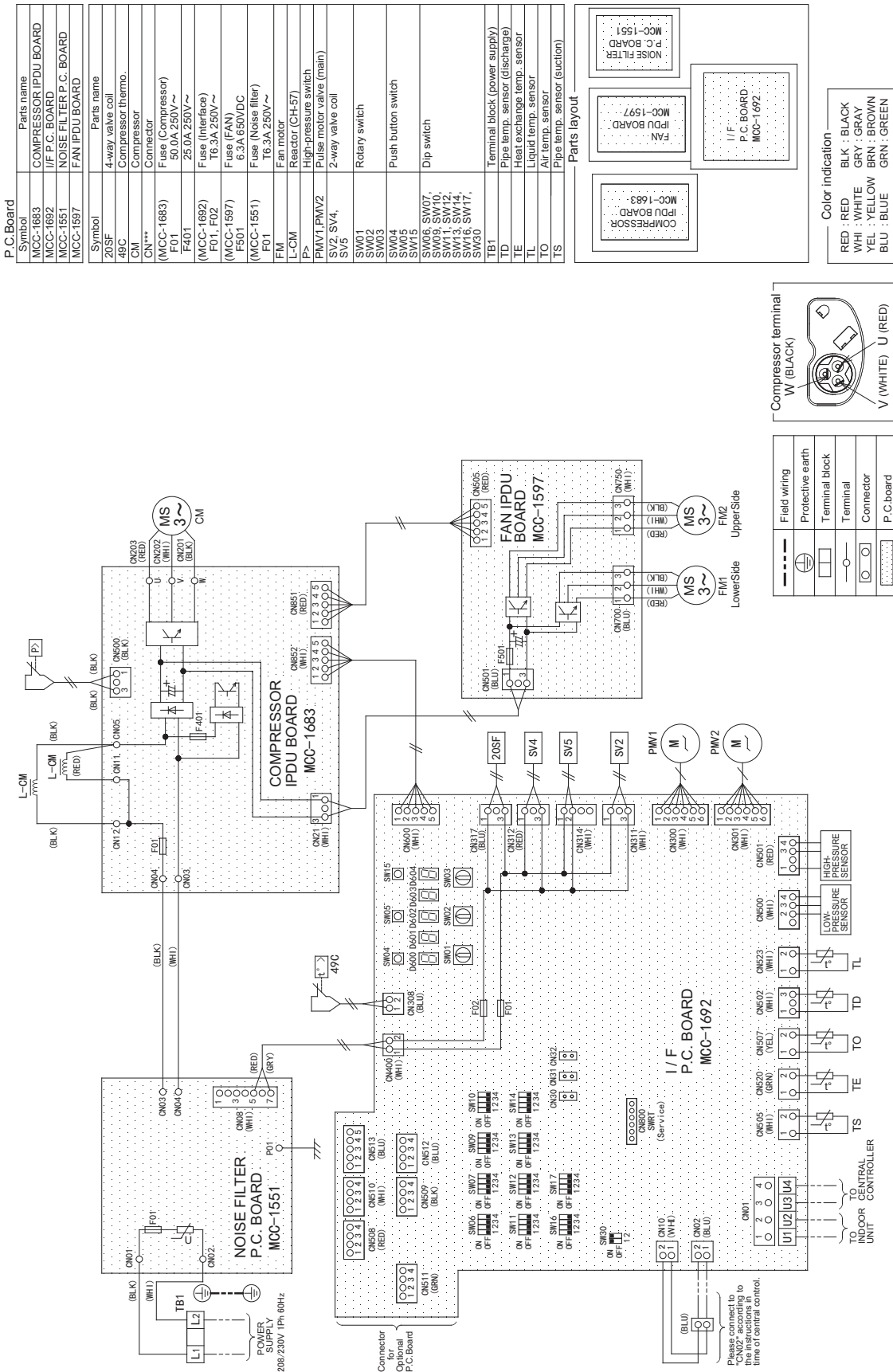

Symbol	Parts name
MCC-1683	COMPRESSOR IPDU BOARD
MCC-1692	I/F P.C. BOARD
MCC-1551	NOISE FILTER P.C. BOARD
MCC-1597	FAN IPDU BOARD
20SF	4-way valve coil
49C	Compressor thermo.
CM	Compressor
CM**	Compressor
(MCC-1683)	Fuse (Compressor)
F01	50.0A 250V~
F02	25.0A 250V~
(MCC-1692)	Fuse (Interface)
F01, F02	T6.3A 250V~
(MCC-1597)	Fuse (FAN)
F01	6.3A 650VDC
(MCC-1551)	Fuse (Noise filter)
F01	T6.3A 250V~
FM	Fan motor
L-CM	Reactor (CH-57)
P>	High-pressure switch
PMV1, PMV2	Pulse motor valve (main)
SV2, SV4, SV5	2-way valve coil
SW01	Rotary switch
SW02	Rotary switch
SW03	Rotary switch
SW04	Rotary switch
SW05	Rotary switch
SW06	Rotary switch
SW07	Rotary switch
SW08, SW10, SW11, SW12, SW13, SW14, SW16, SW17,	Rotary switch
SW15	Push button switch
SW18	Dip switch
TS	Terminal block (power supply)
TD	Pipe temp. sensor (discharge)
TE	Heat exchange temp. sensor
TL	Liquid temp. sensor
TO	Air temp. sensor
TS	Pipe temp. sensor (suction)

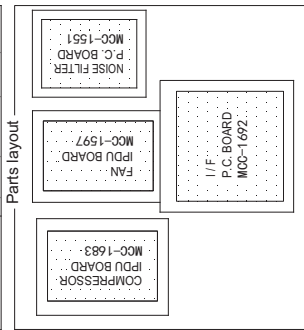

Color indication

RED	: RED
WHI	: WHITE
YEL	: YELLOW
BLU	: BLUE
BLK	: BLACK
GRY	: GRAY
BRN	: BROWN
GRN	: GREEN



Field wiring
Protective earth
Terminal block
Terminal
Connector
P.C. board



5-7. Connecting diagram

Model: MCY-MAP0367HS-UL, MCY-MAP0487HS-UL, MCY-MAP0607HS-UL

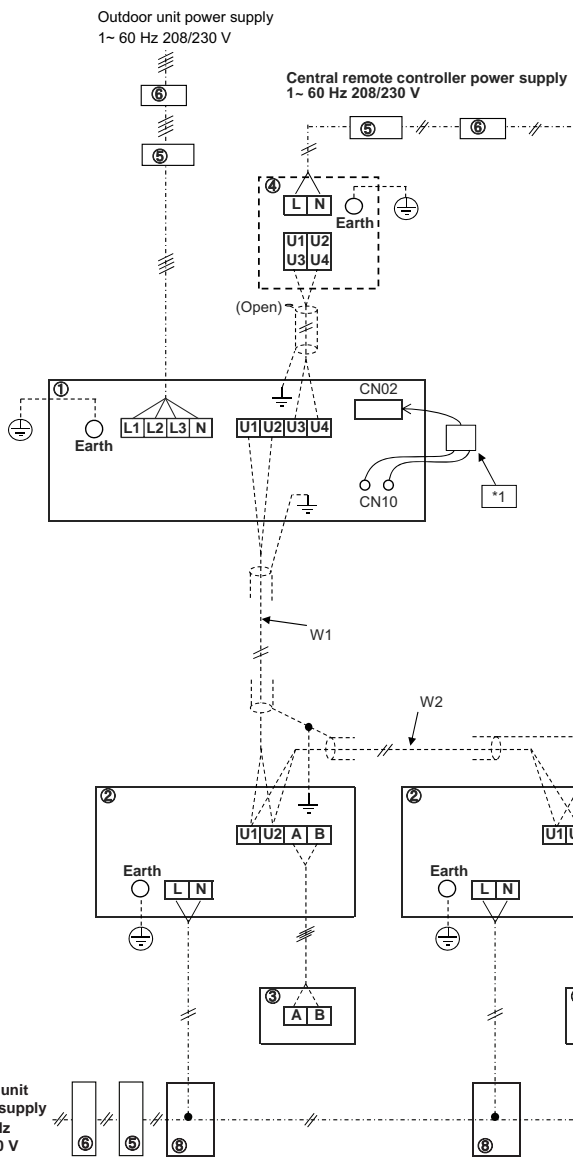

(1)	Outdoor unit
(2)	Indoor unit
(3)	Remote controller
(4)	Central remote controller (option)
(5)	Disconnect switch for NEC
(6)	Circuit breaker

W1	Control wiring between indoor and outdoor units.
W2	Control wiring between indoor units.

(Note)

1. When perform a central control, connect the wire of CN10 in CN02. (Factory default : No connection)
2. Connection of shield wire must be connected. (Connected to all connecting sections in each Indoor unit)
3. Group control
4. Power supply wiring to be per NEC and local codes.
5. For the control wires connecting indoor units, outdoor units, and between indoor and outdoor units, use 2-core and non-polarity shield wires.
6. As for details, see the wiring diagram of indoor/outdoor unit.



5-8. Applied control for Outdoor Unit

The outdoor fan high static pressure support function is made available by setting relevant switches provided on the interface P.C. board of the outdoor unit.

5-8-1. Outdoor Fan High Static Pressure Shift

Purpose/characteristics

This function is used when connecting a duct to the discharge port of an outdoor unit (as part of, for example, unit installation on the floor by floor installation.)

Setup

Turn ON the DIP switch [SW10, Bit 2] provided on the interface P.C. board of the outdoor unit.

This function must be enabled with every discharge duct connected outdoor unit for both of the header and follower units.

Specification

Increase the speed of the propeller fan units on the outdoor fan to allow the installation of a duct with a maximum external static pressure not greater than specified in the table below. If a discharge duct with a resistance greater than 0.04inWG (1.0 mmAq) is to be used,enable this function. The maximum external static pressures of outdoor units are shown below (Table 1).

(Table 1.) Maximum external static pressures of outdoor units

Model name	Maximum external static pressure (inWG)	Outdoor unit air flow (CFM)
MCY-MAP0367HS-UL	0.08	4520
MCY-MAP0487HS-UL	0.08	4690
MCY-MAP0607HS-UL	0.08	4850

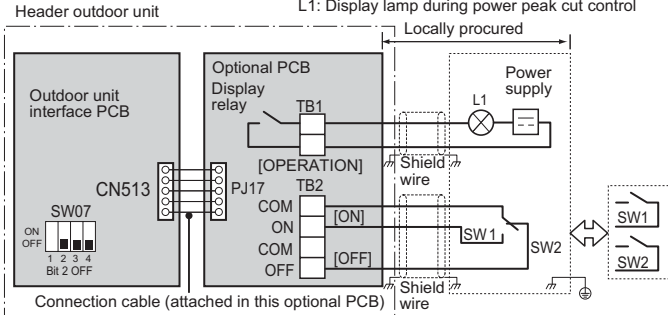
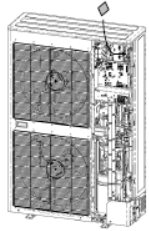

5-9. Optional printed circuit board (PCB) of outdoor unit

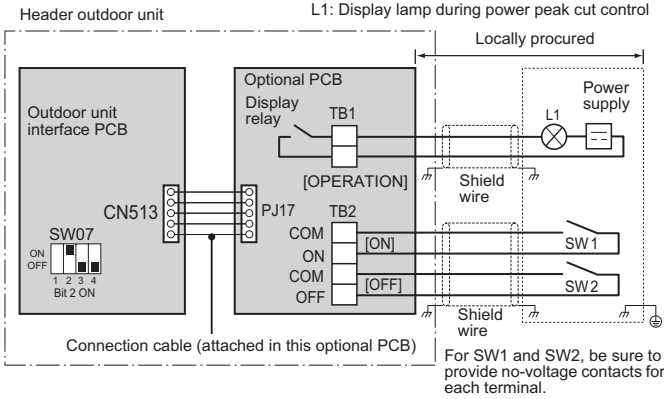
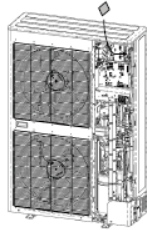
Model name	Appearance	Function																			
TCB-PCDM4UL	 <p style="text-align: center;">Size: 2.80 × 3.35 (in)</p>	<p>Power peak-cut Control Standard Specifications (Wiring example)</p>  <p style="text-align: right; font-size: small;">For SW1 and SW2, be sure to provide no-voltage contacts for each terminal. The input signals of SW1 and SW2 may be pulse input (100 msec or more) or continuous make. Do not turn on [SW1] and [SW2] simultaneously.</p> <p style="text-align: center;"><SW07 (bit 2) OFF [2-stage switching]></p> <table border="1" data-bbox="671 1010 1355 1167"> <thead> <tr> <th colspan="2">Input</th> <th colspan="2">SW07 (bit 1)</th> <th rowspan="2">Display relay (L1)</th> </tr> <tr> <th>SW1</th> <th>SW2</th> <th>Bit 1 OFF</th> <th>Bit 1 ON</th> </tr> </thead> <tbody> <tr> <td>OFF</td> <td>ON</td> <td>100% (normal operation)</td> <td>100% (normal operation)</td> <td>OFF</td> </tr> <tr> <td>ON</td> <td>OFF</td> <td>0% (forced stop)</td> <td>Approx. 60% (upper limit regulated)</td> <td>ON</td> </tr> </tbody> </table>	Input		SW07 (bit 1)		Display relay (L1)	SW1	SW2	Bit 1 OFF	Bit 1 ON	OFF	ON	100% (normal operation)	100% (normal operation)	OFF	ON	OFF	0% (forced stop)	Approx. 60% (upper limit regulated)	ON
	Input		SW07 (bit 1)		Display relay (L1)																
	SW1		SW2	Bit 1 OFF		Bit 1 ON															
OFF	ON	100% (normal operation)	100% (normal operation)	OFF																	
ON	OFF	0% (forced stop)	Approx. 60% (upper limit regulated)	ON																	
<p style="text-align: center;">Application</p>  <p style="text-align: center;">* Installation the optional PCB in the inveter-box of the outdoor unit.</p>																					

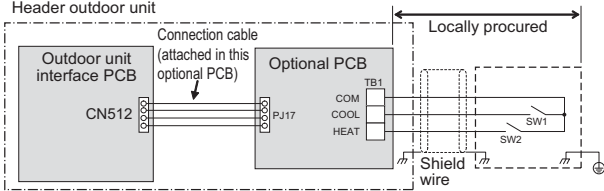

Model name	Appearance	Function
TCB-PCDM4UL	 <p>Size: 2.80 × 3.35 (in)</p>	<p>Enhanced Specifications (Wiring example)</p>  <p>Header outdoor unit</p> <p>L1: Display lamp during power peak cut control</p> <p>Locally procured</p> <p>Outdoor unit interface PCB</p> <p>Optional PCB</p> <p>Display relay</p> <p>TB1</p> <p>[OPERATION]</p> <p>PJ17</p> <p>TB2</p> <p>COM [ON]</p> <p>COM [OFF]</p> <p>OFF</p> <p>Shield wire</p> <p>Power supply</p> <p>L1</p> <p>SW1</p> <p>SW2</p> <p>Shield wire</p> <p>For SW1 and SW2, be sure to provide no-voltage contacts for each terminal.</p> <p>Connection cable (attached in this optional PCB)</p>
	<p>Application</p>	
	 <p>* Install the optional PCB in the inverter assembly of the outdoor header unit.</p>	

<SW07 (bit 2) ON [4-stage switching]>

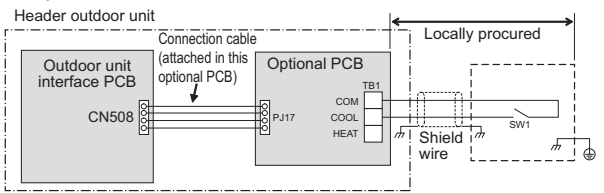
Input		SW07 (bit 1)		Display relay (L1)
SW1	SW2	Bit 1 OFF	Bit 1 ON	
OFF	OFF	100% (normal operation)	100% (normal operation)	OFF
ON	OFF	Approx. 80% (upper limit regulated)	Approx. 85% (upper limit regulated)	ON
OFF	ON	Approx. 60% (upper limit regulated)	Approx. 75% (upper limit regulated)	ON
ON	ON	0% (forced stop)	Approx. 60% (upper limit regulated)	ON

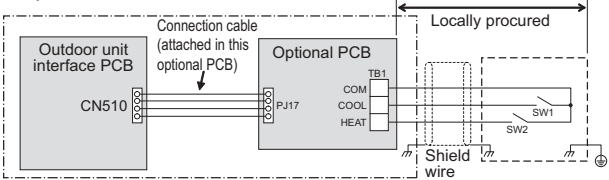
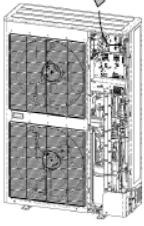
Model name	Appearance	Function																																	
TCB-PCMO4UL	 <p>Size: 2.19 × 2.36 (in)</p>	<p>[1] External master ON/OFF control</p> <p>▼ Function By connecting the cable (attached in this optional PCB) to the interface PC board on an outdoor unit, all indoor units connected to the outdoor unit enable to operate simultaneously.</p> <p>▼ Operation</p>  <p>SW1: Operation input switch SW2: Stop input switch</p> <table border="1" data-bbox="702 784 1388 918"> <thead> <tr> <th>Terminal</th> <th>Input Signal</th> <th>Operation</th> </tr> </thead> <tbody> <tr> <td>COOL (SW1)</td> <td>ON OFF</td> <td>All indoor units operate together</td> </tr> <tr> <td>HEAT (SW2)</td> <td>ON OFF</td> <td>All indoor units stop together</td> </tr> </tbody> </table> <p>Provide no-voltage pulse contacts for each terminal. Hold the ON state for at least 100 msec. Do not turn SW1 and SW2 ON simultaneously</p>	Terminal	Input Signal	Operation	COOL (SW1)	ON OFF	All indoor units operate together	HEAT (SW2)	ON OFF	All indoor units stop together																								
	Terminal	Input Signal	Operation																																
COOL (SW1)	ON OFF	All indoor units operate together																																	
HEAT (SW2)	ON OFF	All indoor units stop together																																	
<p>Application</p>  <p>* Install the optional PCB in the inverter assembly of the outdoor header unit.</p>	<p>[2] Night time operation (sound reduction) control</p> <p>▼ Function As the cable (attached in this optional PCB) is connected to the "Interface PCB" on an outdoor unit, both compressor speed and fan speed are restricted while the signal of the night operation control is input. It makes the noise reduction during the night time operation.</p> <p>▼ Operation</p>  <p>SW1: Night time signal switch</p> <table border="1" data-bbox="702 1489 1372 1624"> <thead> <tr> <th>Terminal</th> <th>Input Signal</th> <th>Operation</th> </tr> </thead> <tbody> <tr> <td rowspan="2">COOL (SW1)</td> <td>ON OFF</td> <td>Night time operation control</td> </tr> <tr> <td>ON OFF</td> <td>Normal operation</td> </tr> </tbody> </table> <p>Each terminal should be connected to dry contact.</p> <p>▼ Sound reduction and approximation capacity (reference)</p> <table border="1" data-bbox="702 1713 1348 1904"> <thead> <tr> <th rowspan="2">Outdoor unit (base unit)</th> <th colspan="2">During low-noise mode dB(A)</th> <th colspan="2">Capacity</th> <th rowspan="2">Relative to maximum capacity</th> </tr> <tr> <th>Cooling</th> <th>Heating</th> <th>Cooling</th> <th>Heating</th> </tr> </thead> <tbody> <tr> <td>Model 0367*</td> <td>45</td> <td>49</td> <td>approx. 85%</td> <td>approx. 90%</td> <td rowspan="3"></td> </tr> <tr> <td>Model 0487*</td> <td>45</td> <td>51</td> <td>approx. 60%</td> <td>approx. 80%</td> </tr> <tr> <td>Model 0607*</td> <td>49</td> <td>52</td> <td>approx. 70%</td> <td>approx. 70%</td> </tr> </tbody> </table> <p>* Position of noise measuring device: 1 m from the front face of the set and 1.5 m above ground (anechoic sound)</p>	Terminal	Input Signal	Operation	COOL (SW1)	ON OFF	Night time operation control	ON OFF	Normal operation	Outdoor unit (base unit)	During low-noise mode dB(A)		Capacity		Relative to maximum capacity	Cooling	Heating	Cooling	Heating	Model 0367*	45	49	approx. 85%	approx. 90%		Model 0487*	45	51	approx. 60%	approx. 80%	Model 0607*	49	52	approx. 70%	approx. 70%
Terminal	Input Signal	Operation																																	
COOL (SW1)	ON OFF	Night time operation control																																	
	ON OFF	Normal operation																																	
Outdoor unit (base unit)	During low-noise mode dB(A)		Capacity		Relative to maximum capacity																														
	Cooling	Heating	Cooling	Heating																															
Model 0367*	45	49	approx. 85%	approx. 90%																															
Model 0487*	45	51	approx. 60%	approx. 80%																															
Model 0607*	49	52	approx. 70%	approx. 70%																															

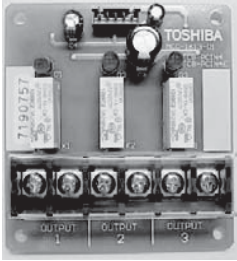
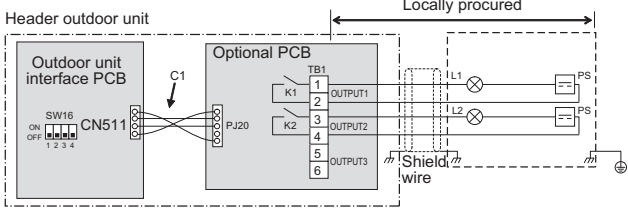
Model name	Appearance	Function																															
TCB-PCMO4UL	 <p>Size: 2.19 × 2.36 (in)</p>	<p>[3] Operation mode selection control</p> <p>▼ Function The heating/cooling mode of the system can be selected by connecting to the interface PCB of outdoor units.</p> <p>▼ Operation</p> 																															
	<p>Application</p>  <p>* Install the optional PCB in the inverter assembly of the outdoor header unit.</p>	<p>SW1: Cooling mode specified input switch SW2: Heating mode specified input switch</p> <table border="1" data-bbox="703 745 1382 887"> <thead> <tr> <th colspan="2">Input Signal</th> <th rowspan="2">Operation: Selected operation mode</th> </tr> <tr> <th>Cooling (SW1)</th> <th>Heating (SW2)</th> </tr> </thead> <tbody> <tr> <td>ON</td> <td>OFF</td> <td>Cooling operation only</td> </tr> <tr> <td>OFF</td> <td>ON</td> <td>Heating operation only</td> </tr> <tr> <td>OFF</td> <td>OFF</td> <td>Normal operation</td> </tr> </tbody> </table> <p>Each terminal should be connected to dry contact.</p> <p>Indoor unit operation intervention function The statuses of indoor units operating in a mode different from the selected operation mode can be changed by changing the status of a jumper wire (J01) provided on the interface P.C. board of outdoor unit.</p> <table border="1" data-bbox="699 1111 1442 1565"> <thead> <tr> <th>Jumper wire</th> <th colspan="2">Description of intervention</th> </tr> </thead> <tbody> <tr> <td>J01 connected (factory default)</td> <td colspan="2">All indoor units operating in a mode different from the selected operation mode (prohibited-mode indoor units) become non-priority units (thermostat OFF). The display "⊙ (operation ready)" appears on the remote controller of prohibited-mode indoor units.</td> </tr> <tr> <td rowspan="4">J01 cut</td> <td colspan="2">The selected operation mode is imposed on all indoor units operating in a different mode.</td> </tr> <tr> <td>Mode selected at P.C. board</td> <td>Remote controller operation / display</td> </tr> <tr> <td>Normal</td> <td>All modes (COOL, DRY, HEAT and FAN) available</td> </tr> <tr> <td>COOL</td> <td>Only COOL, DRY and FAN available</td> </tr> <tr> <td>HEAT</td> <td>Only HEAT and FAN available</td> <td>"⊙ operation mode control" (turned on during remote controller operation)</td> </tr> </tbody> </table>	Input Signal		Operation: Selected operation mode	Cooling (SW1)	Heating (SW2)	ON	OFF	Cooling operation only	OFF	ON	Heating operation only	OFF	OFF	Normal operation	Jumper wire	Description of intervention		J01 connected (factory default)	All indoor units operating in a mode different from the selected operation mode (prohibited-mode indoor units) become non-priority units (thermostat OFF). The display "⊙ (operation ready)" appears on the remote controller of prohibited-mode indoor units.		J01 cut	The selected operation mode is imposed on all indoor units operating in a different mode.		Mode selected at P.C. board	Remote controller operation / display	Normal	All modes (COOL, DRY, HEAT and FAN) available	COOL	Only COOL, DRY and FAN available	HEAT	Only HEAT and FAN available
Input Signal		Operation: Selected operation mode																															
Cooling (SW1)	Heating (SW2)																																
ON	OFF	Cooling operation only																															
OFF	ON	Heating operation only																															
OFF	OFF	Normal operation																															
Jumper wire	Description of intervention																																
J01 connected (factory default)	All indoor units operating in a mode different from the selected operation mode (prohibited-mode indoor units) become non-priority units (thermostat OFF). The display "⊙ (operation ready)" appears on the remote controller of prohibited-mode indoor units.																																
J01 cut	The selected operation mode is imposed on all indoor units operating in a different mode.																																
	Mode selected at P.C. board	Remote controller operation / display																															
	Normal	All modes (COOL, DRY, HEAT and FAN) available																															
	COOL	Only COOL, DRY and FAN available																															
HEAT	Only HEAT and FAN available	"⊙ operation mode control" (turned on during remote controller operation)																															

Model name	Appearance	Function																				
TCB-PCIN4UL	 <p data-bbox="328 629 576 658">Size: 2.87 × 3.11 (in)</p>	<p data-bbox="703 340 1031 369">[1] Error / Operation Output</p> <p data-bbox="715 385 1393 456">▼ Function The operation error output PCB can indicate operation and error states by connecting to the interface PCB of outdoor units.</p> <p data-bbox="715 472 1398 544">▼ Operation Operation output: The operation indicator is on while any indoor unit in the system is operating.</p> <p data-bbox="715 544 1398 591">Error output: The error indicator is on when an error is occurred on even one of the indoor or outdoor units in the system.</p> <p data-bbox="715 618 866 647">Wiring example</p>  <table border="1" data-bbox="718 889 1398 1164"> <tr> <td>C1</td> <td>Attached connection cable 1 (4wires)</td> </tr> <tr> <td>CN511</td> <td>Connector on interface side (green)</td> </tr> <tr> <td>K1, K2</td> <td>Relays</td> </tr> <tr> <td>L1</td> <td>Error indication Lamp</td> </tr> <tr> <td>L2</td> <td>Operation indication Lamp</td> </tr> <tr> <td>OUTPUT1</td> <td>Error output</td> </tr> <tr> <td>OUTPUT2</td> <td>Operation output</td> </tr> <tr> <td>PJ20</td> <td>Connector on optional PCB side</td> </tr> <tr> <td>PS</td> <td>Power supply unit</td> </tr> <tr> <td>TB1</td> <td>Terminal block</td> </tr> </table> <p data-bbox="715 1167 1179 1189">* [OUTPUT3] is displayed when power is turned on.</p>	C1	Attached connection cable 1 (4wires)	CN511	Connector on interface side (green)	K1, K2	Relays	L1	Error indication Lamp	L2	Operation indication Lamp	OUTPUT1	Error output	OUTPUT2	Operation output	PJ20	Connector on optional PCB side	PS	Power supply unit	TB1	Terminal block
	C1	Attached connection cable 1 (4wires)																				
CN511	Connector on interface side (green)																					
K1, K2	Relays																					
L1	Error indication Lamp																					
L2	Operation indication Lamp																					
OUTPUT1	Error output																					
OUTPUT2	Operation output																					
PJ20	Connector on optional PCB side																					
PS	Power supply unit																					
TB1	Terminal block																					
<p data-bbox="400 667 533 696">Application</p>  <p data-bbox="328 987 588 1106">* Install the optional PCB in the inverter assembly of the outdoor header unit.</p>																						

[PCB Installation Position]

There are holes on the inverter-box.
Three kinds of the optional PCBs are able to install in it.

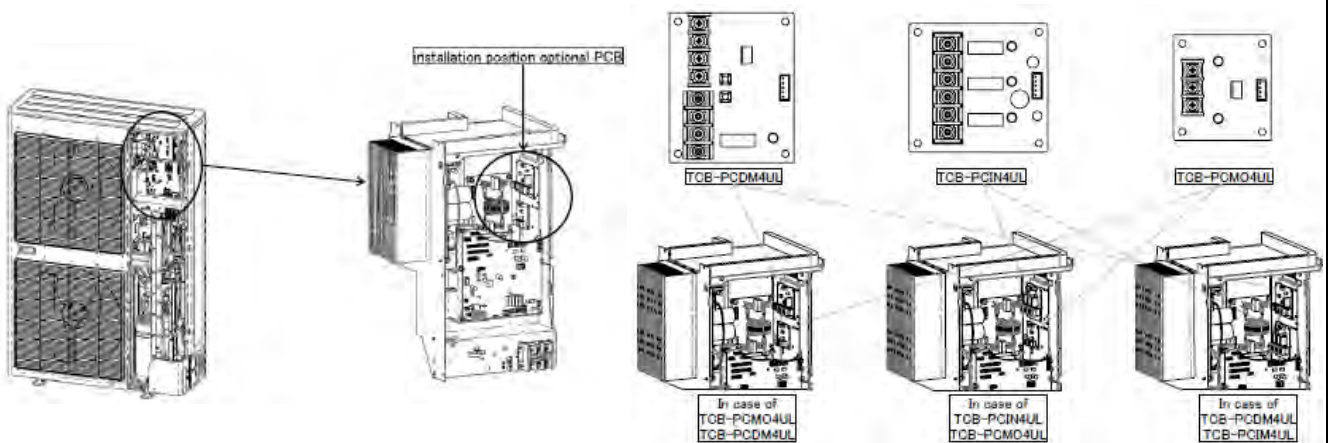

5-10. Sound pressure level data [Measuring location]

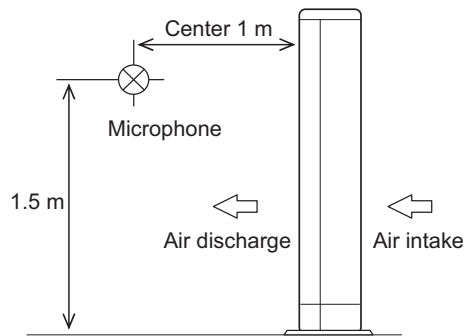

MCY-MAP0367HS-UL

Sound pressure level (dB(A))	Cooling	Heating
	52.0	55.0

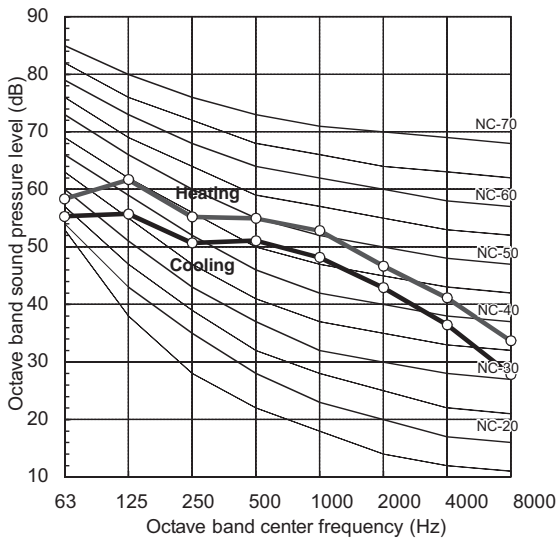

MCY-MAP0487HS-UL

Sound pressure level (dB(A))	Cooling	Heating
	54.0	57.0

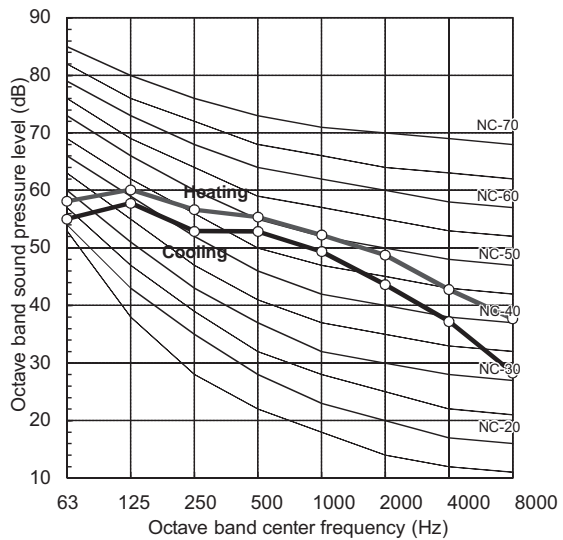

MCY-MAP0607HS-UL

Sound pressure level (dB(A))	Cooling	Heating
	55.0	58.0

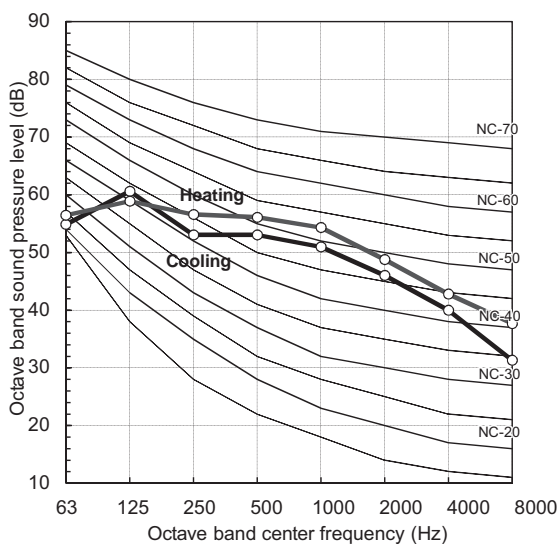

Engineering Data Book

Model name:

MCY-MAP__7HS-UL

December, 2016 (1st)

July, 2023 (2nd)

Vertical Air Handling Unit type

Engineering Databook

MMD-AP0120VHG2UL
MMD-AP0180VHG2UL
MMD-AP0240VHG2UL
MMD-AP0300VHG2UL
MMD-AP0360VHG2UL
MMD-AP0420VHG2UL
MMD-AP0480VHG2UL
MMD-AP0600VHG2UL

Contents

1. Specifications
2. Dimensions
3. Center of gravity
4. Piping diagram
5. Wiring diagram
6. Electrical characteristics
7. Sensible capacity table
8. Fan characteristics
9. Accessories



1. Specifications



Vertical Air Handling Unit Type

Tonnage		1	1.5	2	2.5	3	3.5	4	5										
Model name		MMD-AP	0120VHG2UL	0180VHG2UL	0240VHG2UL	0300VHG2UL	0360VHG2UL	0420VHG2UL	0480VHG2UL	0600VHG2UL									
Cooling capacity		Btu/h	12,000	18,000	24,000	30,000	36,000	42,000	48,000	60,000									
Heating capacity		Btu/h	13,500	20,000	27,000	34,000	40,000	45,000	54,000	67,000									
		kW	4.0	5.9	7.9	10.0	11.7	13.2	15.8	19.6									
Electrical characteristics	Power supply		208/230V 1ph 60Hz																
	Power consumption (*1)		kW	0.12	0.174	0.178	0.296	0.41	0.386	0.496	0.938								
	MCA		A	1.9	2.8	2.8	4.5	4.5	6.1	7.5	9.5								
	MOCP		A	15															
Dimension	Unit	Height	in		46.9		51.9		55.9		57.9								
		Width	in		17.7		20.2		22.2		24.2								
		Depth	in		22.3		25.3		27.3		31.3								
	Packing	Height	in		53.5		53.5		58.5		62.5		64.5						
		Width	in		24		24		24		24		28						
		Depth	in		30		30		30		30		33						
Total weight	Unit	lbs	130		164		170		200		253								
	Packed unit	lbs	157		191		216		257		336								
Heat Exchanger	Type	Finned tube																	
	Shape	Slab																	
	Row x Length (inch)	2 X 17		3 X 17			3 X 20		3 X 22		3 X 26								
Fan unit	Type	Sirocco fan																	
	Nominal air volume	cfm	480		670		760		1,000		1,160		1,400		1,600		2,000		
	Air Volume (at standard static pressure)	High	cfm	480		670		760		1,000		1,200		1,400		1,600		2,000	
		Mid	cfm	440		640		660		990		1,150		1,340		1,510		1,830	
		Low	cfm	340		600		600		950		1,050		1,260		1,420		1,640	
	Fan motor	Type	Direct drive (EC motor)																
		HP	1/3HP			1/2HP			3/4HP			1HP							
External static pressure (*2)	Standard.	in W.G.	0.3			0.5			0.8										
	Max.	in W.G.	0.5			0.8													
Connecting Pipe	Liquid side	in	"1/4 (Braze)			"3/8 (Braze)			"3/8 (Braze)										
	Gas side	in	"3/8 (Braze)		"1/2 (Braze)		"5/8 (Braze)												
	Drain port (Nominal dia.)	in	3/4" FPT																
Orientation	Vertical / Horizontal Right																		
Color	Gray																		
Filter (Standard)	MERV 3 (1inch)																		
Filter Box (Option) / MERV8 (2inch)	TCB-FB2F241VDGUL			TCB-FB2F361VDGUL			TCB-FB2F481VDGUL			TCB-FB2F601VDGUL									
Plenum (option)	TCB-PL2S241VDGUL			TCB-PL2S361VDGUL			TCB-PL2S481VDGUL			TCB-PL2S601VDGUL									
Electrical Heater (Option) (240V/208V)	1.0kW/0.8kW	TCB-HT101VDGUL	✓	✓	✓	✓	✓	✓	✓	✓	✓								
	3.0kW/2.3kW	TCB-HT301VDGUL	✓	✓	✓	✓	✓	✓	✓	✓	✓								
	5.0kW/3.8kW	TCB-HT501VDGUL	✓	✓	✓	✓	✓	✓	✓	✓	✓								
	6.0kW/4.5kW	TCB-HT601VDGUL	✓	✓	✓	✓	✓	✓	✓	✓	✓								
	8.0kW/6.0kW	TCB-HT801VDGUL	✓	✓	✓	✓	✓	✓	✓	✓	✓								
9.5kW/7.1kW	TCB-HT951VDGUL	✓	✓	✓	✓	✓	✓	✓	✓	✓									
Remote control	RBM-AMT54E-UL / RBM-AMT32UL / RBC-AS41UL / TCB-TC41LUL (Remote sensor) / TCB-AX32UL (Wireless kit)																		
Central control	BMS-CM1281TLUL / BMS-SM1280HTLUL (Web browser)																		
Open protocol interface	BMS-IFBN640TLUL / TCB-IFLN642TLUL / OPN-MTCC																		
Connector	TCB-KBCN32VEE / TCB-KBCN60OPE / TCB-KBCN70OAE / TCB-KBCN73DEE / TCB-KBCN80EXE																		
Secondary Heating	Secondary heating auxiliary		Available																
	Secondary heating flip		Available																
	Secondary heating active by TO		Available																
	Constant fan (Heating fan control)		Available																

[Note]

(*1) The value is based on the standard external static pressure with high tap fan mode.

(*2) With standard MERV 3 filter attached.

2. Dimensions (RH Drain Connection, Bottom Return)

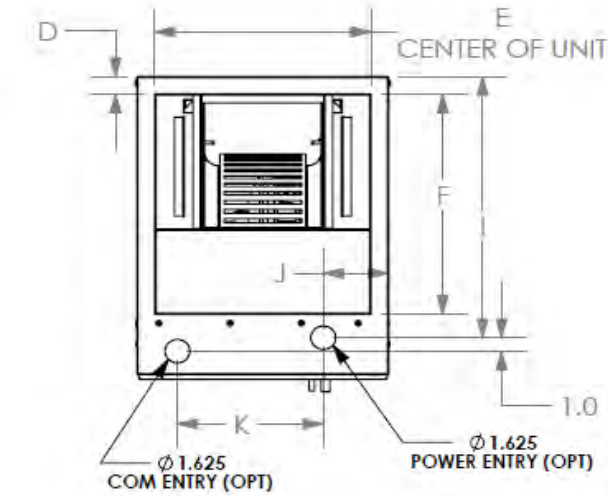

Model	Coil Connection					
	012	018	024	030/036	042/048	060
L	0.250	0.250	0.375	0.375	0.375	0.375
M	0.375	0.5	0.625	0.625	0.625	0.625
N	1.9	1.9	1.9	1.9	1.9	1.9
O	3.0	3.0	3.0	3.0	3.0	3.0
P	9.3	9.3	9.3	11.4	12.5	13.1
Q	12.6	12.6	12.6	15.7	17.1	18.8
R	1.5	1.5	1.5	2.1	1.7	1.7
S	2.6	2.6	2.6	3.2	2.8	2.8
T	4.4	4.4	4.4	6.5	7.0	7.6
U	5.4	5.4	5.4	8.1	8.8	10.3

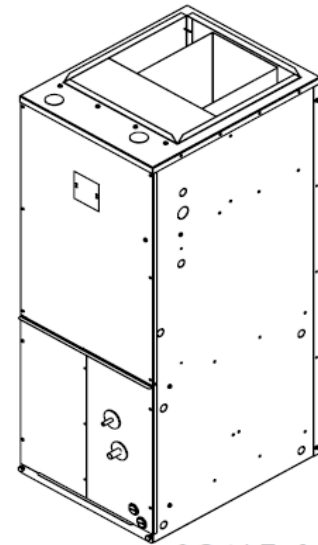
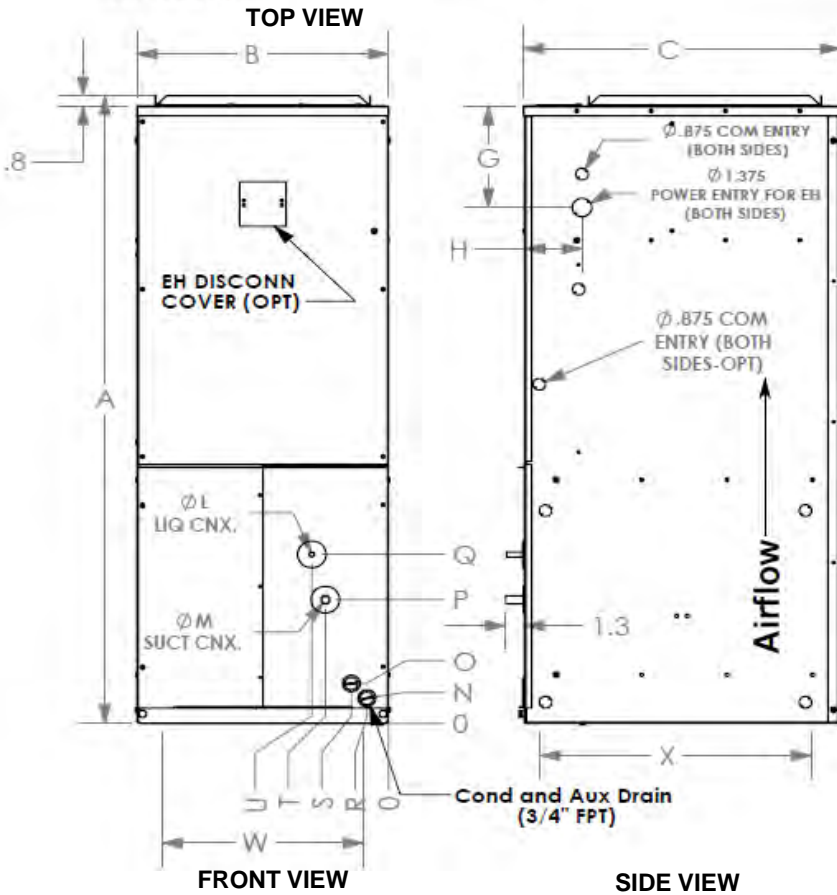

SCALE: 1:16

Model	Height A	Width B	Depth C	Discharge duct			Electrical connection				Return opening		
				D	E	F	G	H	I	J	K	W	X
012/018/024	46.9	17.7	22.3	1.3	15.2	16.4	7.6	4.0	19.5	4.6	10.2	14.1	19.0
030/036	51.9	20.2	25.3	1.6	17.2	19.1	7.6	4.0	22.5	4.9	11.5	16.6	22.2
042/048	55.9	22.2	27.3	1.6	19.2	21.2	7.6	4.0	24.4	5.8	12.7	18.0	23.7
060	57.9	24.2	31.3	1.6	21.2	25.2	7.6	4.0	28.3	5.8	15.6	18.0	27.0

2. Dimensions (RH Drain Connection, LH Return)

Coil Connection						
Model	012	018	024	030/036	042/048	060
L	0.250	0.250	0.375	0.375	0.375	0.375
M	0.375	0.5	0.625	0.625	0.625	0.625
N	1.9	1.9	1.9	1.9	1.9	1.9
O	3.0	3.0	3.0	3.0	3.0	3.0
P	9.3	9.3	9.3	11.4	12.5	13.1
Q	12.6	12.6	12.6	15.7	17.1	18.8
R	1.5	1.5	1.5	2.1	1.7	1.7
S	2.6	2.6	2.6	3.2	2.8	2.8
T	4.4	4.4	4.4	6.5	7.0	7.6
U	5.4	5.4	5.4	8.1	8.8	10.3

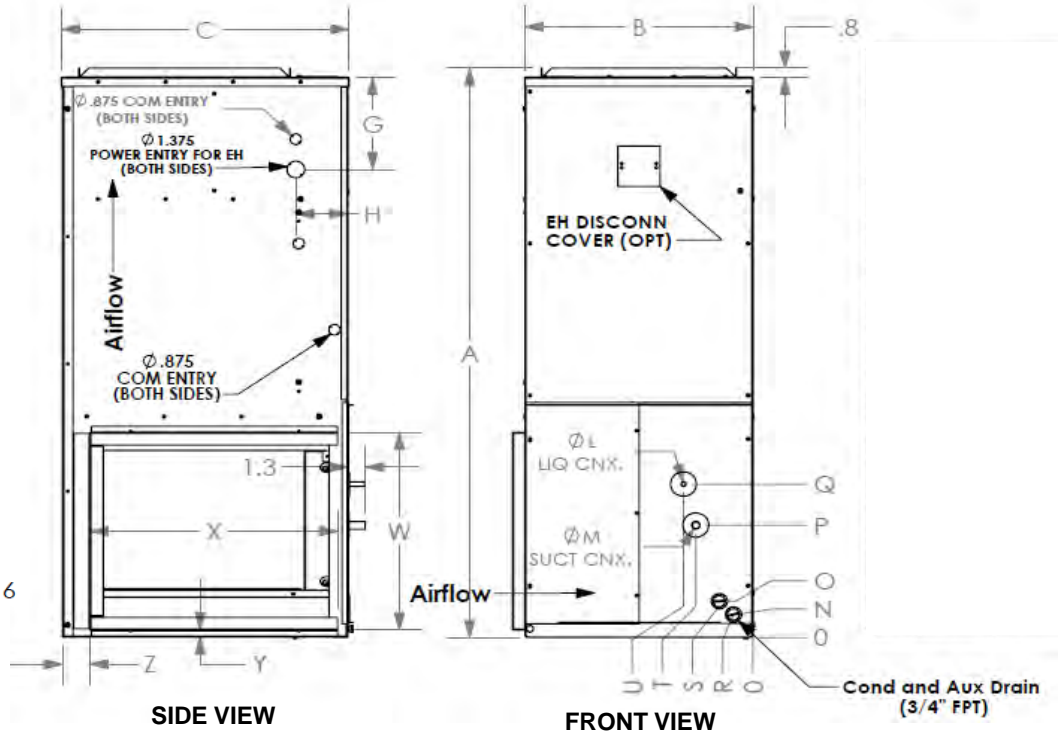
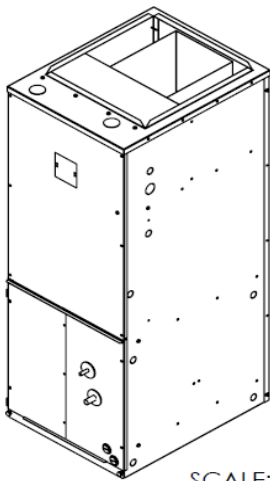
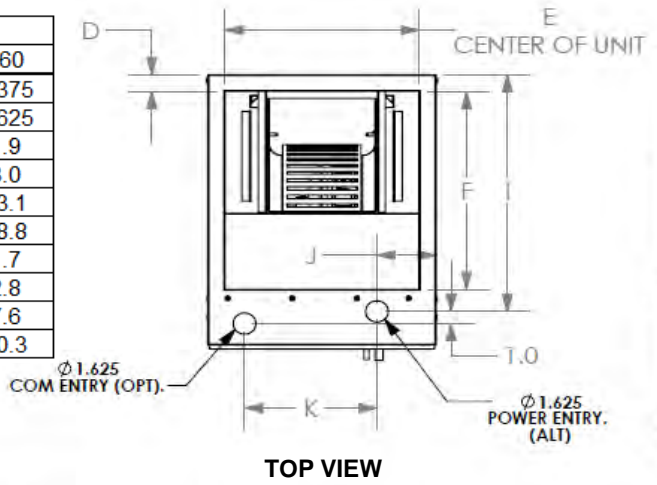

Model	Height	Width	Depth	Discharge duct			Electrical connection					Return duct			
	A	B	C	D	E	F	G	H	I	J	K	W	X	Y	Z
012/018/024	46.9	17.7	22.3	1.3	15.2	16.4	7.6	4.0	19.5	4.6	10.2	16.3	19.2	0.6	1.3
030/036	51.9	20.2	25.3	1.6	17.2	19.1	7.6	4.0	22.5	4.9	11.5	18.2	23.3	2.8	0.4
042/048	55.9	22.2	27.3	1.6	19.2	21.2	7.6	4.0	24.4	5.8	12.7	21.0	24.2	0.9	0.9
060	57.9	24.2	31.3	1.6	21.2	25.2	7.6	4.0	28.3	5.8	15.6	21.0	28.8	2.0	0.4

2. Dimensions
Filter Box

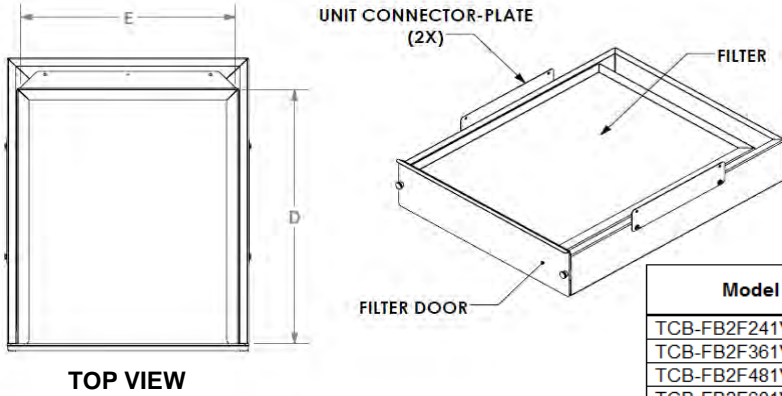

Model	Height	Width	Depth	Filter	
	A	B	C	D	E
TCB-FB2F241VDGUL	3.8	17.5	22.2	20.0	16.0
TCB-FB2F361VDGUL	3.8	20.0	25.2	24.0	18.0
TCB-FB2F481VDGUL	3.8	22.0	27.2	25.0	20.0
TCB-FB2F601VDGUL	3.8	24.0	31.2	30.0	20.0

Unit : Inch

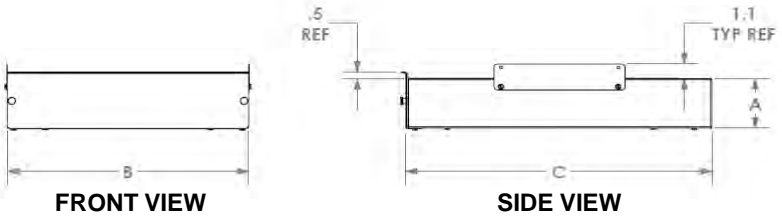

Plenum

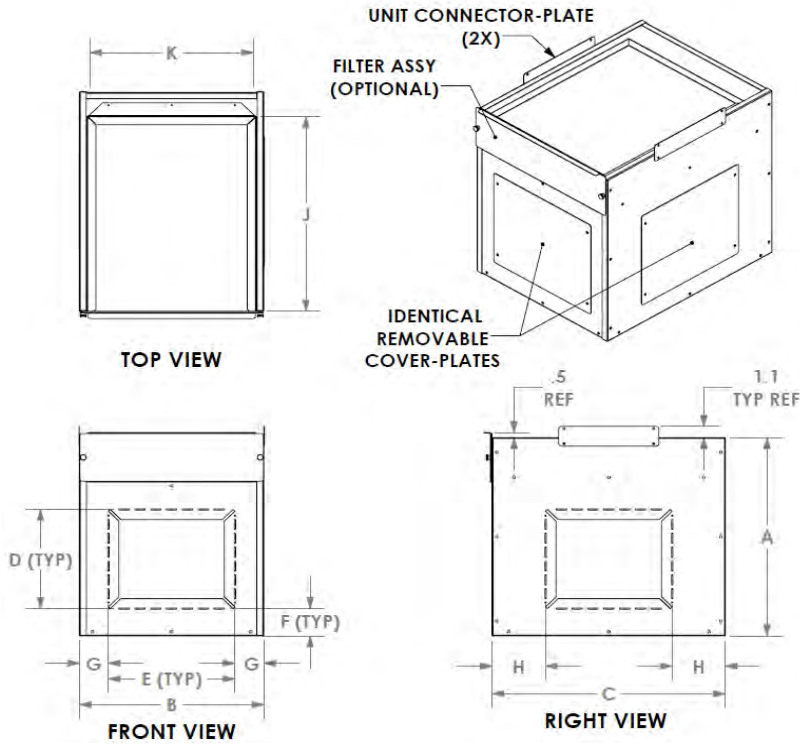

Model	Height	Width	Depth	Return - Opening				Filter		
	A	B	C	D	E	F	G	H	J	K
TCB-PL2S241VDGUL	20.0	17.5	22.1	10.0	12.0	2.8	2.6	5.1	20.0	16.0
TCB-PL2S361VDGUL	20.0	20.0	25.1	12.0	15.0	1.8	2.3	5.1	24.0	18.0
TCB-PL2S481VDGUL	24.0	22.0	27.1	15.0	16.0	2.3	2.8	5.6	25.0	20.0
TCB-PL2S601VDGUL	24.0	24.0	31.1	16.0	18.0	1.8	2.8	5.6	30.0	20.0

Unit : Inch

3. Center of gravity

3-1. Vertical orientation

Model	Height		Width		Depth		Center of gravity	
	A	B	C	D	E			
012	46.9	17.7	22.3	11.1	9.1			
018/024	46.9	17.7	22.3	10.4	9.5			
030/036	51.9	20.2	25.3	12.8	10.2			
042/048	55.9	20.2	27.3	13.5	11.1			
060	57.9	24.2	31.3	15.3	12.2			

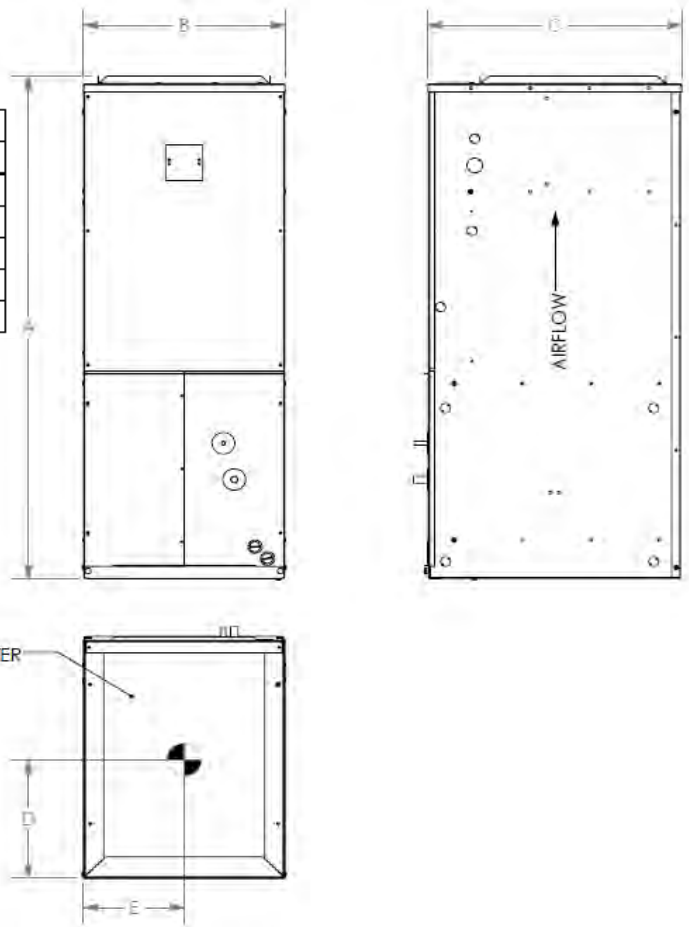

3-2. Horizontal orientation

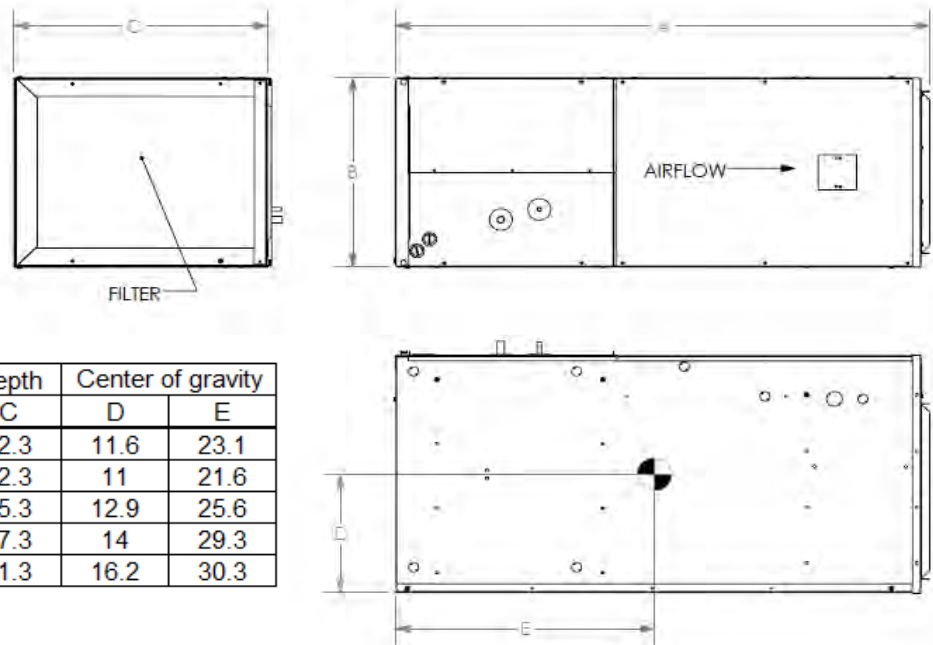

Model	Height		Width		Depth		Center of gravity	
	A	B	C	D	E			
012	46.9	17.7	22.3	11.6	23.1			
018/024	46.9	17.7	22.3	11	21.6			
030/036	51.9	20.2	25.3	12.9	25.6			
042/048	55.9	20.2	27.3	14	29.3			
060	57.9	24.2	31.3	16.2	30.3			

4. Piping diagram

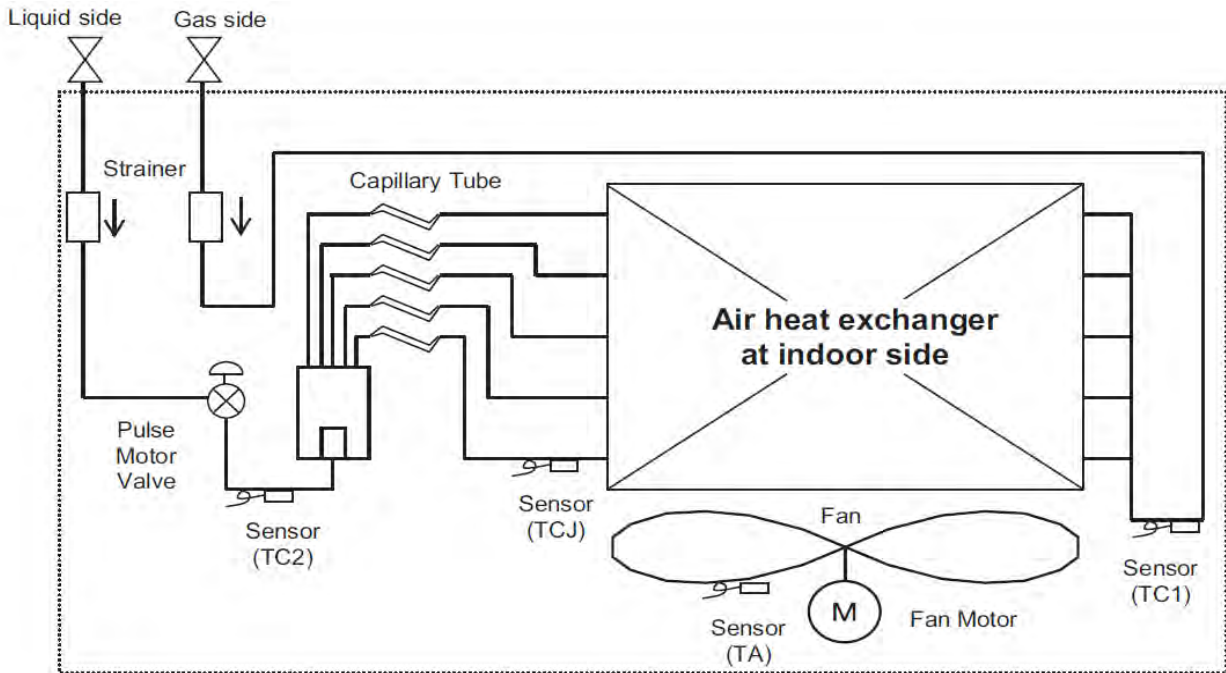

Explanation of functional parts in indoor unit

Functional part name		Function outline
Pulse Motor Valve	PMV	(Connector CN082 (6P) : Blue) 1) Controls superheat in cooling operation 2) Controls subcooling in heating operation 3) Recovers refrigerant oil in cooling operation 4) Recovers refrigerant oil in heating operation
Temperature sensor	TA	(Connector CN104 (3P) : Yellow) 1) Detects indoor suction temperature
	TC1	(Connector CN100 (3P) : Brown) 1) Controls PMV super heat in cooling operation
	TC2	(Connector CN101 (2P) : Black) 1) Controls PMV sub cool in heating operation
	TCJ	(Connector CN102 (2P) : Red) 1) Controls PMV super heat in cooling operation

5. Wiring diagram

MMD-AP0120VHG2UL, AP0180VHG2UL, AP0240VHG2UL, AP0300VHG2UL, MMD-AP0360VHG2UL, AP0420VHG2UL, AP0480VHG2UL, AP0600VHG2UL

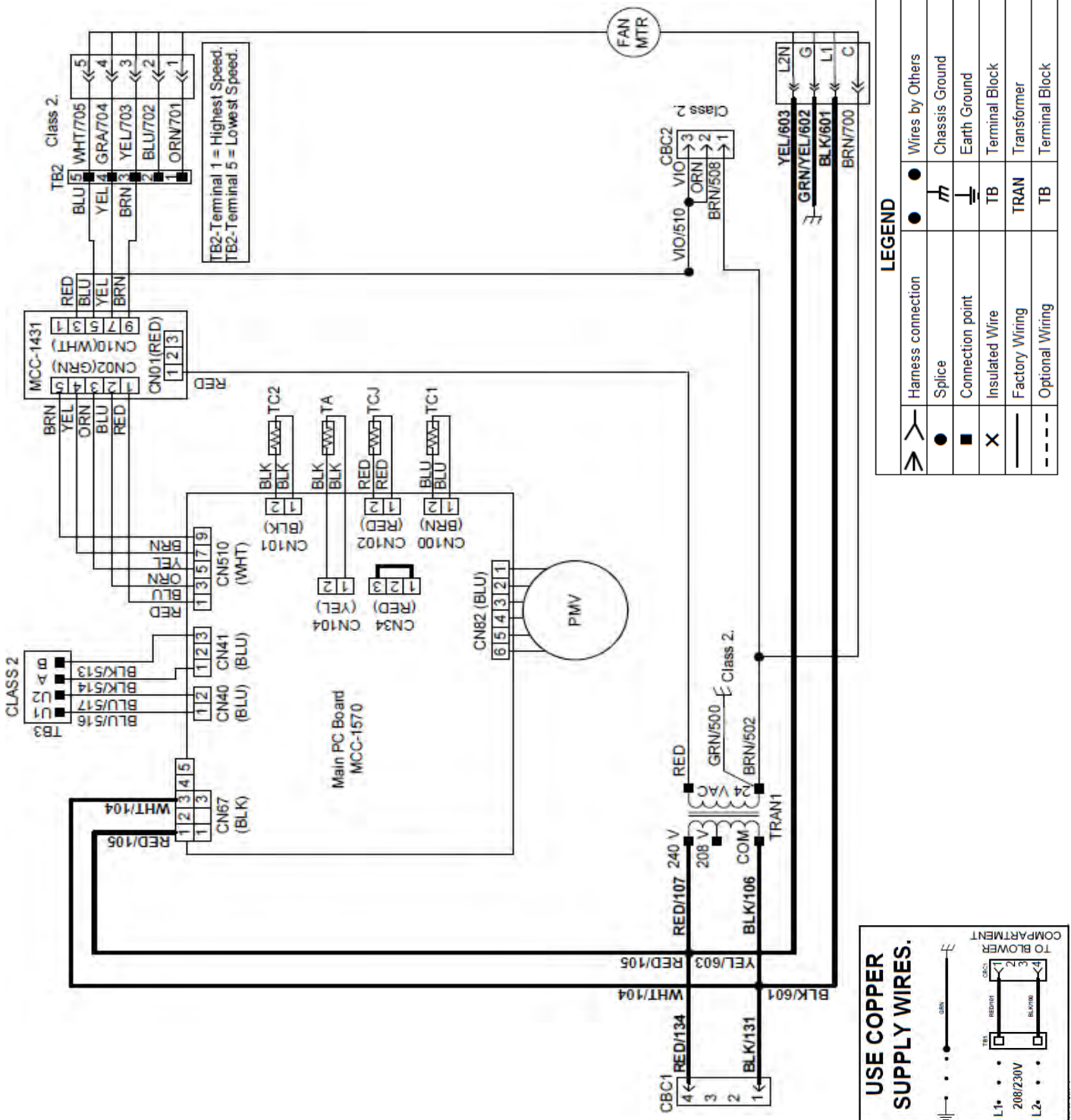

5. Wiring diagram

Electrical heater (3kW,5kW,6kW)

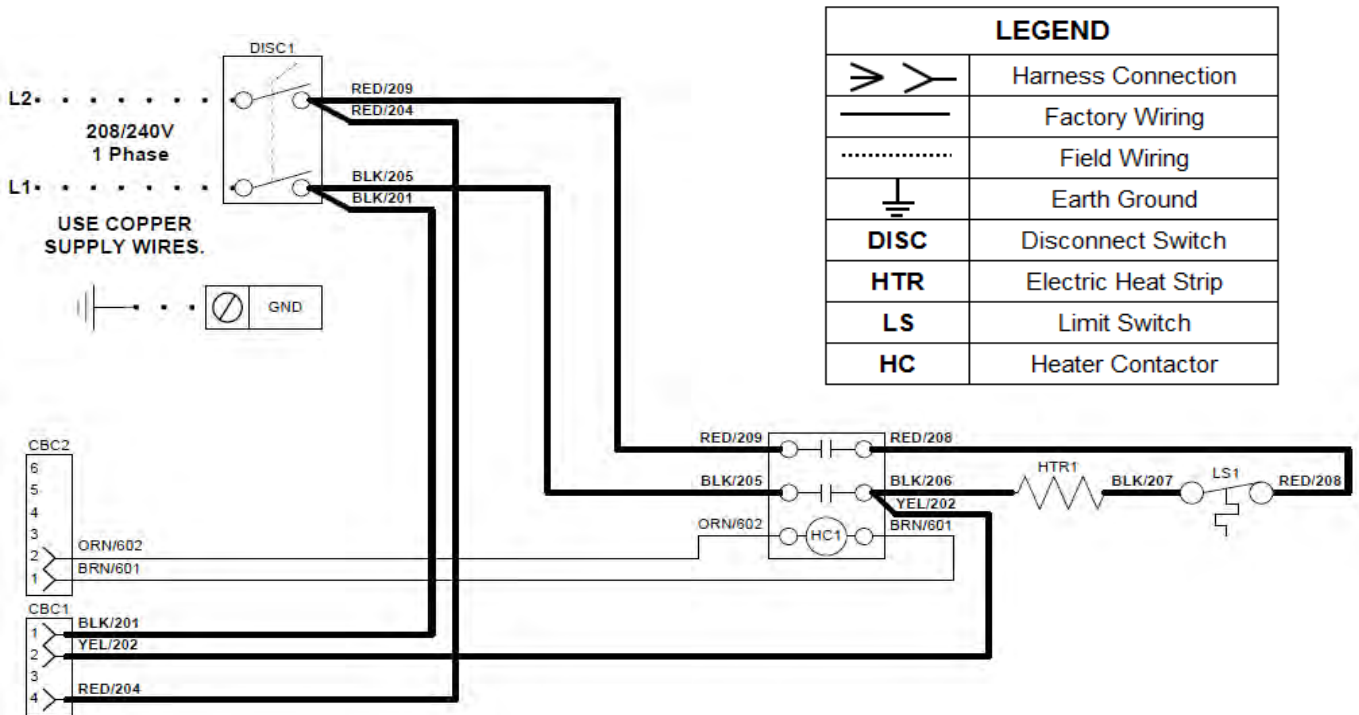

LEGEND	
	Harness Connection
	Factory Wiring
	Field Wiring
	Earth Ground
DISC	Disconnect Switch
HTR	Electric Heat Strip
LS	Limit Switch
HC	Heater Contactor

Electrical heater (8kW, 9.5kW)

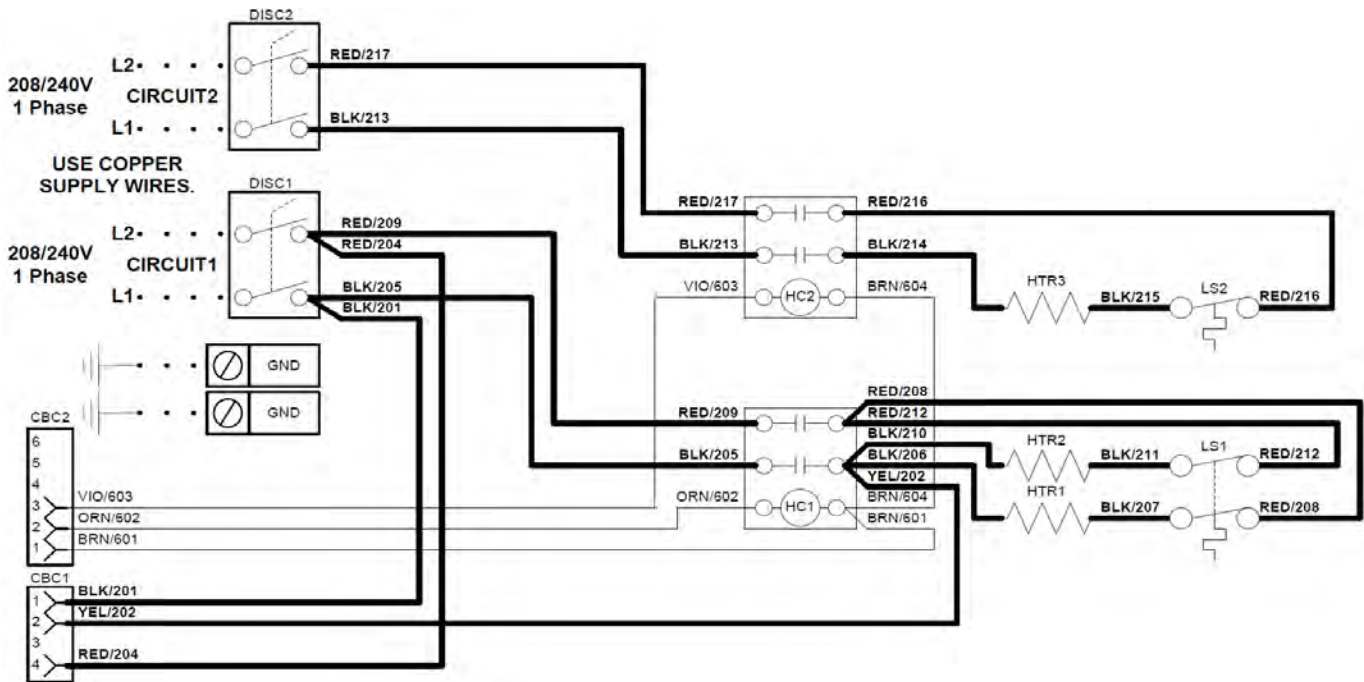

6. Electrical data

Size	Motor HP	Motor FLA 240-208V	TOTAL ELECTRIC HEAT (KW)		ELECTRIC HEAT AMPS		UNIT FLA		MINIMUM CIRCUIT AMPACITY (MCA) (A)		Maximum Overcurrent Protective Device (MOPD) (A)		MIN WIRE SIZE AWG*
			240	208	CIRCUIT 1		CIRCUIT 1		CIRCUIT 1		CIRCUIT 1		
					240	208	240	208	240	208	240	208	
012	1/3	1.3	NONE		NONE		1.5	1.5	1.9	1.9	15	15	14
			1.0	0.8	4.2	3.6	5.5	4.9	6.8	6.1	15	15	14
			3.0	2.3	12.5	10.8	13.8	12.1	17.3	15.2	15	15	14
			5.0	3.8	20.8	18.1	22.1	19.4	27.7	24.2	30	25	10/12
018 024	1/3	2.2	NONE		NONE		2.2	2.2	2.8	2.8	15	15	14
			1.0	0.8	4.2	3.6	6.4	5.8	8.0	7.3	15	15	14
			3.0	2.3	12.5	10.8	14.7	13.0	18.4	16.3	15	15	14
			5.0	3.8	20.8	18.1	23.0	20.3	28.8	25.3	30	25	10/12
			6.0	4.5	25.0	21.7	27.2	23.9	34.0	29.8	35	30	8/10
030 036	1/2	3.6	NONE		NONE		3.6	3.6	4.5	4.5	15	15	14
			1.0	0.8	4.2	3.6	7.8	7.2	9.7	9.0	15	15	14
			3.0	2.3	12.5	10.8	16.1	14.4	20.1	18.0	25	20	10
			5.0	3.8	20.8	18.1	24.4	21.7	30.5	27.1	35	30	8
			6.0	4.5	25.0	21.7	28.6	25.3	35.8	31.6	40	35	8
			8.0	6.0	33.3	28.9	36.9	32.5	46.2	40.6	50	45	8
042	3/4	4.9	NONE		NONE		4.9	4.9	6.1	6.1	15	15	14
			1.0	0.8	4.2	3.6	9.1	8.5	11.3	10.6	15	15	14
			3.0	2.3	12.5	10.8	17.4	15.7	21.8	19.7	25	20	10
			5.0	3.8	20.8	18.1	25.7	23.0	32.2	28.7	35	30	10
			6.0	4.5	25.0	21.7	29.9	26.6	37.4	33.2	40	35	8
			8.0	6.0	33.3	28.9	38.2	33.8	47.8	42.2	50	45	8
048	3/4	6.0	NONE		NONE		6.0	6.0	7.5	7.5	15	15	14
			1.0	0.8	4.2	3.6	10.2	9.6	12.7	12.0	15	15	14
			3.0	2.3	12.5	10.8	18.5	16.8	23.1	21.0	25	25	10
			5.0	3.8	20.8	18.1	26.8	24.1	33.5	30.1	35	35	10
			6.0	4.5	25.0	21.7	31.0	27.7	38.8	34.6	40	35	8
			8.0	6.0	33.3	28.9	39.3	34.9	49.2	43.6	50	45	8
060	1	7.6	NONE		NONE		7.6	7.6	9.5	9.5	15	15	14
			1.0	0.8	4.2	3.6	11.8	11.2	14.7	14.0	15	15	14
			3.0	2.3	12.5	10.8	20.1	18.4	25.1	23.0	30	25	10
			5.0	3.8	20.8	18.1	28.4	25.7	35.5	32.1	40	35	8
			6.0	4.5	25.0	21.7	32.6	29.3	40.8	36.6	45	40	8
			8.0	6.0	33.3	28.9	40.9	36.5	51.2	45.6	60	50	6
			9.5	7.1	39.6	34.3	47.2	41.9	59.0	52.4	60	60	6

Notes:

*1. Minimum Wire Gauge is based upon Circuit 1 ampacity and the use of 75C wire at the unit.

MCA : Minimum Circuit Amps

MOPD : Maximum Overcurrent Protection Device (Amps)

FLA : Full Load Amps

AWG : American Wiring Gauge

7.Sensible Capacity Tables (MMD-AP***0VHG2UL)

TC : Total capacity [Btu/h] SHC : Sensible capacity [Btu/h]

Unit size	Outdoor air temp. °FDB	Indoor air temp.													
		59° FWB		61° FWB		64° FWB		67° FWB		68° FWB		72° FWB		75° FWB	
		71° FDB		73° FDB		77° FDB		80° FDB		82° FDB		86° FDB		90° FDB	
		TC	SHC	TC	SHC	TC	SHC	TC	SHC	TC	SHC	TC	SHC	TC	SHC
012	50	10,210	8,270	10,690	8,500	11,360	8,840	12,000	9,120	12,210	9,150	12,980	9,030	13,510	8,690
	54	10,210	8,270	10,690	8,500	11,360	8,840	12,000	9,120	12,210	9,150	12,980	9,030	13,510	8,690
	57	10,210	8,270	10,690	8,500	11,360	8,840	12,000	9,120	12,210	9,150	12,980	9,030	13,510	8,690
	61	10,210	8,270	10,690	8,500	11,360	8,840	12,000	9,120	12,210	9,150	12,980	9,030	13,510	8,690
	64	10,210	8,270	10,690	8,500	11,360	8,840	12,000	9,120	12,210	9,150	12,980	9,030	13,510	8,690
	68	10,210	8,270	10,690	8,500	11,360	8,840	12,000	9,120	12,210	9,150	12,980	9,030	13,510	8,690
	70	10,210	8,270	10,690	8,500	11,360	8,840	12,000	9,120	12,210	9,150	12,980	9,030	13,510	8,690
	73	10,210	8,270	10,690	8,500	11,360	8,840	12,000	9,120	12,210	9,150	12,980	9,030	13,510	8,690
	77	10,210	8,270	10,690	8,500	11,360	8,840	12,000	9,120	12,210	9,150	12,980	9,030	13,510	8,690
	81	10,210	8,270	10,690	8,500	11,360	8,840	12,000	9,120	12,210	9,150	12,980	9,030	13,510	8,690
	84	10,210	8,270	10,690	8,500	11,360	8,840	12,000	9,120	12,210	9,150	12,980	9,030	13,510	8,690
	88	10,210	8,270	10,690	8,500	11,360	8,840	12,000	9,120	12,210	9,150	12,980	9,030	13,510	8,690
91	10,210	8,270	10,690	8,500	11,360	8,840	12,000	9,120	12,210	9,150	12,980	9,030	13,510	8,690	
95	10,210	8,270	10,690	8,500	11,360	8,840	12,000	9,120	12,210	9,150	12,980	9,030	13,510	8,690	
99	9,910	8,030	10,380	8,250	11,030	8,580	11,650	8,860	11,860	8,880	12,600	8,770	13,120	8,440	
102	9,680	7,840	10,130	8,060	10,770	8,380	11,380	8,650	11,580	8,670	12,310	8,560	12,810	8,240	
018	50	15,320	12,400	16,030	12,740	17,040	13,260	18,000	13,680	18,310	13,720	19,470	13,550	20,270	13,040
	54	15,320	12,400	16,030	12,740	17,040	13,260	18,000	13,680	18,310	13,720	19,470	13,550	20,270	13,040
	57	15,320	12,400	16,030	12,740	17,040	13,260	18,000	13,680	18,310	13,720	19,470	13,550	20,270	13,040
	61	15,320	12,400	16,030	12,740	17,040	13,260	18,000	13,680	18,310	13,720	19,470	13,550	20,270	13,040
	64	15,320	12,400	16,030	12,740	17,040	13,260	18,000	13,680	18,310	13,720	19,470	13,550	20,270	13,040
	68	15,320	12,400	16,030	12,740	17,040	13,260	18,000	13,680	18,310	13,720	19,470	13,550	20,270	13,040
	70	15,320	12,400	16,030	12,740	17,040	13,260	18,000	13,680	18,310	13,720	19,470	13,550	20,270	13,040
	73	15,320	12,400	16,030	12,740	17,040	13,260	18,000	13,680	18,310	13,720	19,470	13,550	20,270	13,040
	77	15,320	12,400	16,030	12,740	17,040	13,260	18,000	13,680	18,310	13,720	19,470	13,550	20,270	13,040
	81	15,320	12,400	16,030	12,740	17,040	13,260	18,000	13,680	18,310	13,720	19,470	13,550	20,270	13,040
	84	15,320	12,400	16,030	12,740	17,040	13,260	18,000	13,680	18,310	13,720	19,470	13,550	20,270	13,040
	88	15,320	12,400	16,030	12,740	17,040	13,260	18,000	13,680	18,310	13,720	19,470	13,550	20,270	13,040
91	15,320	12,400	16,030	12,740	17,040	13,260	18,000	13,680	18,310	13,720	19,470	13,550	20,270	13,040	
95	15,320	12,400	16,030	12,740	17,040	13,260	18,000	13,680	18,310	13,720	19,470	13,550	20,270	13,040	
99	14,880	12,040	15,570	12,370	16,550	12,880	17,480	13,280	17,780	13,320	18,910	13,160	19,680	12,660	
102	14,520	11,760	15,200	12,080	16,150	12,570	17,060	12,970	17,360	13,010	18,460	12,850	19,220	12,360	
024	50	20,430	16,100	21,370	16,540	22,730	17,220	24,000	17,760	24,410	17,810	25,960	17,590	27,020	16,920
	54	20,430	16,100	21,370	16,540	22,730	17,220	24,000	17,760	24,410	17,810	25,960	17,590	27,020	16,920
	57	20,430	16,100	21,370	16,540	22,730	17,220	24,000	17,760	24,410	17,810	25,960	17,590	27,020	16,920
	61	20,430	16,100	21,370	16,540	22,730	17,220	24,000	17,760	24,410	17,810	25,960	17,590	27,020	16,920
	64	20,430	16,100	21,370	16,540	22,730	17,220	24,000	17,760	24,410	17,810	25,960	17,590	27,020	16,920
	68	20,430	16,100	21,370	16,540	22,730	17,220	24,000	17,760	24,410	17,810	25,960	17,590	27,020	16,920
	70	20,430	16,100	21,370	16,540	22,730	17,220	24,000	17,760	24,410	17,810	25,960	17,590	27,020	16,920
	73	20,430	16,100	21,370	16,540	22,730	17,220	24,000	17,760	24,410	17,810	25,960	17,590	27,020	16,920
	77	20,430	16,100	21,370	16,540	22,730	17,220	24,000	17,760	24,410	17,810	25,960	17,590	27,020	16,920
	81	20,430	16,100	21,370	16,540	22,730	17,220	24,000	17,760	24,410	17,810	25,960	17,590	27,020	16,920
	84	20,430	16,100	21,370	16,540	22,730	17,220	24,000	17,760	24,410	17,810	25,960	17,590	27,020	16,920
	88	20,430	16,100	21,370	16,540	22,730	17,220	24,000	17,760	24,410	17,810	25,960	17,590	27,020	16,920
91	20,430	16,100	21,370	16,540	22,730	17,220	24,000	17,760	24,410	17,810	25,960	17,590	27,020	16,920	
95	20,430	16,100	21,370	16,540	22,730	17,220	24,000	17,760	24,410	17,810	25,960	17,590	27,020	16,920	
99	19,840	15,630	20,750	16,060	22,070	16,720	23,300	17,240	23,700	17,290	25,210	17,080	26,240	16,430	
102	19,370	15,260	20,260	15,680	21,550	16,320	22,750	16,840	23,140	16,880	24,610	16,680	25,610	16,040	
030	50	25,530	20,670	26,720	21,240	28,410	22,110	30,000	22,800	30,510	22,860	32,450	22,580	33,780	21,730
	54	25,530	20,670	26,720	21,240	28,410	22,110	30,000	22,800	30,510	22,860	32,450	22,580	33,780	21,730
	57	25,530	20,670	26,720	21,240	28,410	22,110	30,000	22,800	30,510	22,860	32,450	22,580	33,780	21,730
	61	25,530	20,670	26,720	21,240	28,410	22,110	30,000	22,800	30,510	22,860	32,450	22,580	33,780	21,730
	64	25,530	20,670	26,720	21,240	28,410	22,110	30,000	22,800	30,510	22,860	32,450	22,580	33,780	21,730
	68	25,530	20,670	26,720	21,240	28,410	22,110	30,000	22,800	30,510	22,860	32,450	22,580	33,780	21,730
	70	25,530	20,670	26,720	21,240	28,410	22,110	30,000	22,800	30,510	22,860	32,450	22,580	33,780	21,730
	73	25,530	20,670	26,720	21,240	28,410	22,110	30,000	22,800	30,510	22,860	32,450	22,580	33,780	21,730
	77	25,530	20,670	26,720	21,240	28,410	22,110	30,000	22,800	30,510	22,860	32,450	22,580	33,780	21,730
	81	25,530	20,670	26,720	21,240	28,410	22,110	30,000	22,800	30,510	22,860	32,450	22,580	33,780	21,730
	84	25,530	20,670	26,720	21,240	28,410	22,110	30,000	22,800	30,510	22,860	32,450	22,580	33,780	21,730
	88	25,530	20,670	26,720	21,240	28,410	22,110	30,000	22,800	30,510	22,860	32,450	22,580	33,780	21,730
91	25,530	20,670	26,720	21,240	28,410	22,110	30,000	22,800	30,510	22,860	32,450	22,580	33,780	21,730	
95	25,530	20,670	26,720	21,240	28,410	22,110	30,000	22,800	30,510	22,860	32,450	22,580	33,780	21,730	
99	24,790	20,070	25,950	20,620	27,590	21,470	29,130	22,140	29,630	22,200	31,510	21,930	32,800	21,100	
102	24,200	19,600	25,330	20,140	26,930	20,960	28,440	21,610	28,920	21,670	30,760	21,410	32,020	20,600	

7.Sensible Capacity Tables (MMD-AP***0VHG2UL)

TC : Total capacity [Btu/h] SHC : Sensible capacity [Btu/h]

unit size	outdoor air temp. °FDB	Indoor air temp.													
		59 ° FWB		61 ° FWB		64 ° FWB		67 ° FWB		68 ° FWB		72 ° FWB		75 ° FWB	
		71 ° FDB		73 ° FDB		77 ° FDB		80 ° FDB		82 ° FDB		86 ° FDB		90 ° FDB	
		TC	SHC	TC	SHC	TC	SHC	TC	SHC	TC	SHC	TC	SHC	TC	SHC
036	50	30,640	24,150	32,060	24,820	34,090	25,830	36,000	26,640	36,620	26,720	38,930	26,370	40,540	25,390
	54	30,640	24,150	32,060	24,820	34,090	25,830	36,000	26,640	36,620	26,720	38,930	26,370	40,540	25,390
	57	30,640	24,150	32,060	24,820	34,090	25,830	36,000	26,640	36,620	26,720	38,930	26,370	40,540	25,390
	61	30,640	24,150	32,060	24,820	34,090	25,830	36,000	26,640	36,620	26,720	38,930	26,370	40,540	25,390
	64	30,640	24,150	32,060	24,820	34,090	25,830	36,000	26,640	36,620	26,720	38,930	26,370	40,540	25,390
	68	30,640	24,150	32,060	24,820	34,090	25,830	36,000	26,640	36,620	26,720	38,930	26,370	40,540	25,390
	70	30,640	24,150	32,060	24,820	34,090	25,830	36,000	26,640	36,620	26,720	38,930	26,370	40,540	25,390
	73	30,640	24,150	32,060	24,820	34,090	25,830	36,000	26,640	36,620	26,720	38,930	26,370	40,540	25,390
	77	30,640	24,150	32,060	24,820	34,090	25,830	36,000	26,640	36,620	26,720	38,930	26,370	40,540	25,390
	81	30,640	24,150	32,060	24,820	34,090	25,830	36,000	26,640	36,620	26,720	38,930	26,370	40,540	25,390
	84	30,640	24,150	32,060	24,820	34,090	25,830	36,000	26,640	36,620	26,720	38,930	26,370	40,540	25,390
	88	30,640	24,150	32,060	24,820	34,090	25,830	36,000	26,640	36,620	26,720	38,930	26,370	40,540	25,390
	91	30,640	24,150	32,060	24,820	34,090	25,830	36,000	26,640	36,620	26,720	38,930	26,370	40,540	25,390
95	30,640	24,150	32,060	24,820	34,090	25,830	36,000	26,640	36,620	26,720	38,930	26,370	40,540	25,390	
99	29,750	23,450	31,130	24,100	33,100	25,080	34,960	25,870	35,560	25,950	37,800	25,610	39,360	24,650	
102	29,050	22,890	30,390	23,530	32,320	24,490	34,130	25,250	34,720	25,330	36,910	25,000	38,430	24,070	
042	50	35,750	28,940	37,400	29,730	39,770	30,950	42,000	31,920	42,720	32,010	45,420	31,600	47,290	30,420
	54	35,750	28,940	37,400	29,730	39,770	30,950	42,000	31,920	42,720	32,010	45,420	31,600	47,290	30,420
	57	35,750	28,940	37,400	29,730	39,770	30,950	42,000	31,920	42,720	32,010	45,420	31,600	47,290	30,420
	61	35,750	28,940	37,400	29,730	39,770	30,950	42,000	31,920	42,720	32,010	45,420	31,600	47,290	30,420
	64	35,750	28,940	37,400	29,730	39,770	30,950	42,000	31,920	42,720	32,010	45,420	31,600	47,290	30,420
	68	35,750	28,940	37,400	29,730	39,770	30,950	42,000	31,920	42,720	32,010	45,420	31,600	47,290	30,420
	70	35,750	28,940	37,400	29,730	39,770	30,950	42,000	31,920	42,720	32,010	45,420	31,600	47,290	30,420
	73	35,750	28,940	37,400	29,730	39,770	30,950	42,000	31,920	42,720	32,010	45,420	31,600	47,290	30,420
	77	35,750	28,940	37,400	29,730	39,770	30,950	42,000	31,920	42,720	32,010	45,420	31,600	47,290	30,420
	81	35,750	28,940	37,400	29,730	39,770	30,950	42,000	31,920	42,720	32,010	45,420	31,600	47,290	30,420
	84	35,750	28,940	37,400	29,730	39,770	30,950	42,000	31,920	42,720	32,010	45,420	31,600	47,290	30,420
	88	35,750	28,940	37,400	29,730	39,770	30,950	42,000	31,920	42,720	32,010	45,420	31,600	47,290	30,420
	91	35,750	28,940	37,400	29,730	39,770	30,950	42,000	31,920	42,720	32,010	45,420	31,600	47,290	30,420
95	35,750	28,940	37,400	29,730	39,770	30,950	42,000	31,920	42,720	32,010	45,420	31,600	47,290	30,420	
99	34,710	28,100	36,320	28,870	38,620	30,050	40,780	30,990	41,480	31,080	44,100	30,680	45,920	29,540	
102	33,890	27,440	35,460	28,180	37,700	29,340	39,820	30,260	40,500	30,350	43,060	29,960	44,830	28,840	
048	50	40,850	32,200	42,740	33,080	45,450	34,440	48,000	35,520	48,820	35,620	51,910	35,160	54,050	33,850
	54	40,850	32,200	42,740	33,080	45,450	34,440	48,000	35,520	48,820	35,620	51,910	35,160	54,050	33,850
	57	40,850	32,200	42,740	33,080	45,450	34,440	48,000	35,520	48,820	35,620	51,910	35,160	54,050	33,850
	61	40,850	32,200	42,740	33,080	45,450	34,440	48,000	35,520	48,820	35,620	51,910	35,160	54,050	33,850
	64	40,850	32,200	42,740	33,080	45,450	34,440	48,000	35,520	48,820	35,620	51,910	35,160	54,050	33,850
	68	40,850	32,200	42,740	33,080	45,450	34,440	48,000	35,520	48,820	35,620	51,910	35,160	54,050	33,850
	70	40,850	32,200	42,740	33,080	45,450	34,440	48,000	35,520	48,820	35,620	51,910	35,160	54,050	33,850
	73	40,850	32,200	42,740	33,080	45,450	34,440	48,000	35,520	48,820	35,620	51,910	35,160	54,050	33,850
	77	40,850	32,200	42,740	33,080	45,450	34,440	48,000	35,520	48,820	35,620	51,910	35,160	54,050	33,850
	81	40,850	32,200	42,740	33,080	45,450	34,440	48,000	35,520	48,820	35,620	51,910	35,160	54,050	33,850
	84	40,850	32,200	42,740	33,080	45,450	34,440	48,000	35,520	48,820	35,620	51,910	35,160	54,050	33,850
	88	40,850	32,200	42,740	33,080	45,450	34,440	48,000	35,520	48,820	35,620	51,910	35,160	54,050	33,850
	91	40,850	32,200	42,740	33,080	45,450	34,440	48,000	35,520	48,820	35,620	51,910	35,160	54,050	33,850
95	40,850	32,200	42,740	33,080	45,450	34,440	48,000	35,520	48,820	35,620	51,910	35,160	54,050	33,850	
99	39,670	31,270	41,500	32,120	44,130	33,440	46,610	34,490	47,400	34,590	50,400	34,140	52,480	32,870	
102	38,730	30,530	40,520	31,360	43,090	32,650	45,500	33,670	46,280	33,770	49,210	33,330	51,240	32,090	
060	50	51,070	40,260	53,430	41,360	56,810	43,040	60,000	44,400	61,030	44,530	64,890	43,960	67,560	42,310
	54	51,070	40,260	53,430	41,360	56,810	43,040	60,000	44,400	61,030	44,530	64,890	43,960	67,560	42,310
	57	51,070	40,260	53,430	41,360	56,810	43,040	60,000	44,400	61,030	44,530	64,890	43,960	67,560	42,310
	61	51,070	40,260	53,430	41,360	56,810	43,040	60,000	44,400	61,030	44,530	64,890	43,960	67,560	42,310
	64	51,070	40,260	53,430	41,360	56,810	43,040	60,000	44,400	61,030	44,530	64,890	43,960	67,560	42,310
	68	51,070	40,260	53,430	41,360	56,810	43,040	60,000	44,400	61,030	44,530	64,890	43,960	67,560	42,310
	70	51,070	40,260	53,430	41,360	56,810	43,040	60,000	44,400	61,030	44,530	64,890	43,960	67,560	42,310
	73	51,070	40,260	53,430	41,360	56,810	43,040	60,000	44,400	61,030	44,530	64,890	43,960	67,560	42,310
	77	51,070	40,260	53,430	41,360	56,810	43,040	60,000	44,400	61,030	44,530	64,890	43,960	67,560	42,310
	81	51,070	40,260	53,430	41,360	56,810	43,040	60,000	44,400	61,030	44,530	64,890	43,960	67,560	42,310
	84	51,070	40,260	53,430	41,360	56,810	43,040	60,000	44,400	61,030	44,530	64,890	43,960	67,560	42,310
	88	51,070	40,260	53,430	41,360	56,810	43,040	60,000	44,400	61,030	44,530	64,890	43,960	67,560	42,310
	91	51,070	40,260	53,430	41,360	56,810	43,040	60,000	44,400	61,030	44,530	64,890	43,960	67,560	42,310
95	51,070	40,260	53,430	41,360	56,810	43,040	60,000	44,400	61,030	44,530	64,890	43,960	67,560	42,310	
99	49,590	39,090	51,880	40,160	55,160	41,790	58,260	43,110	59,260	43,240	63,010	42,690	65,600	41,080	
102	48,410	38,170	50,650	39,210	53,860	40,800	56,880	42,090	57,860	42,210	61,520	41,670	64,050	40,110	

8. Fan characteristics

MMD-AP00120VHG2UL

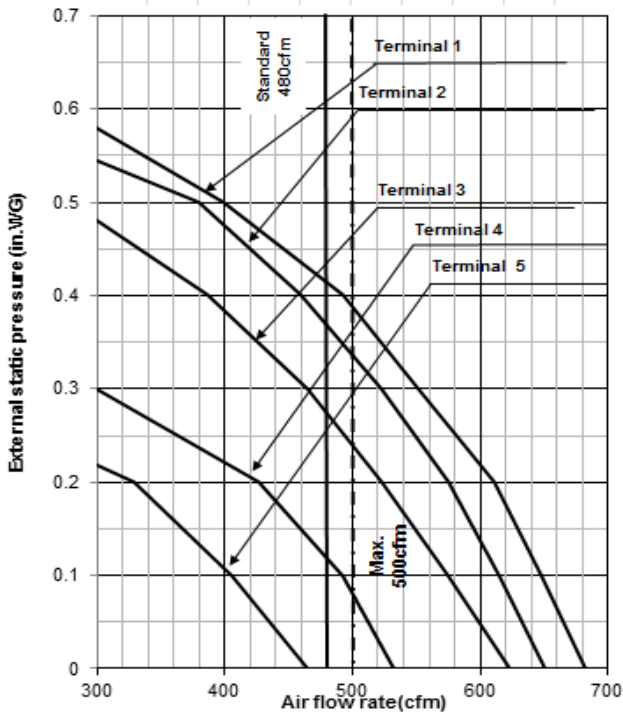

MMD-AP0180VHG2UL

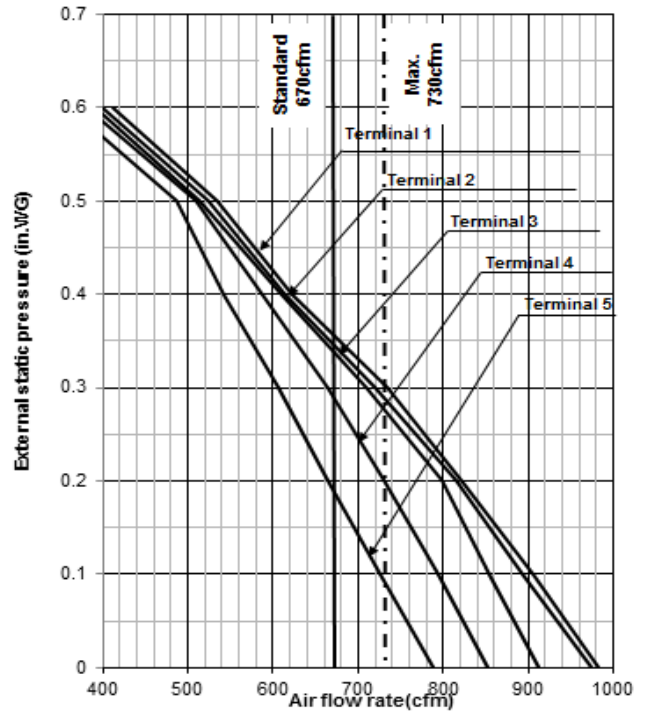

MMD-AP0240VHG2UL

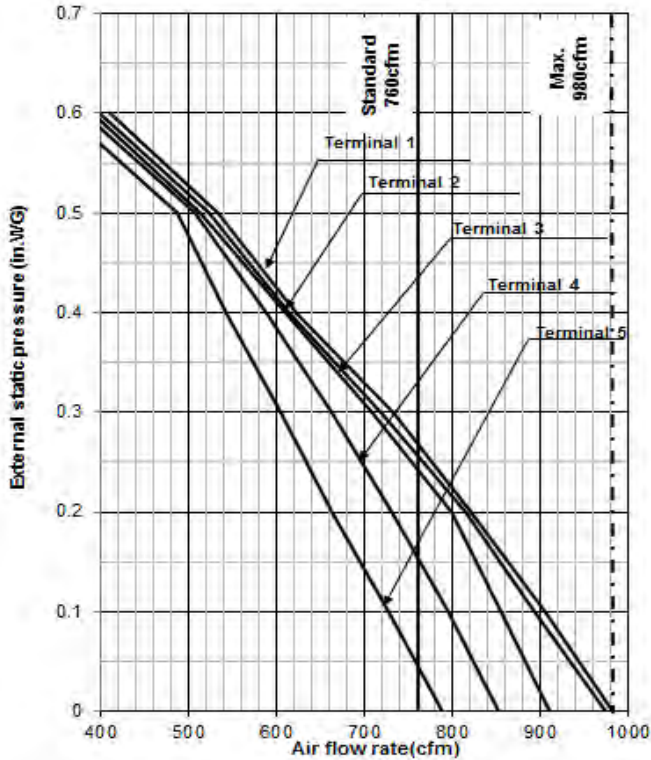

MMD-AP0300VHG2UL

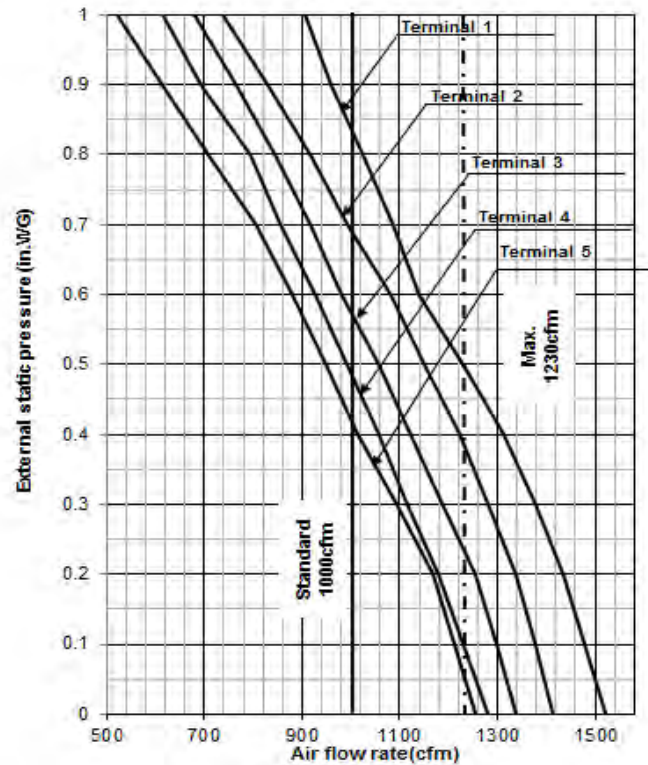

8. Fan characteristics

MMD-AP0360VHG2UL

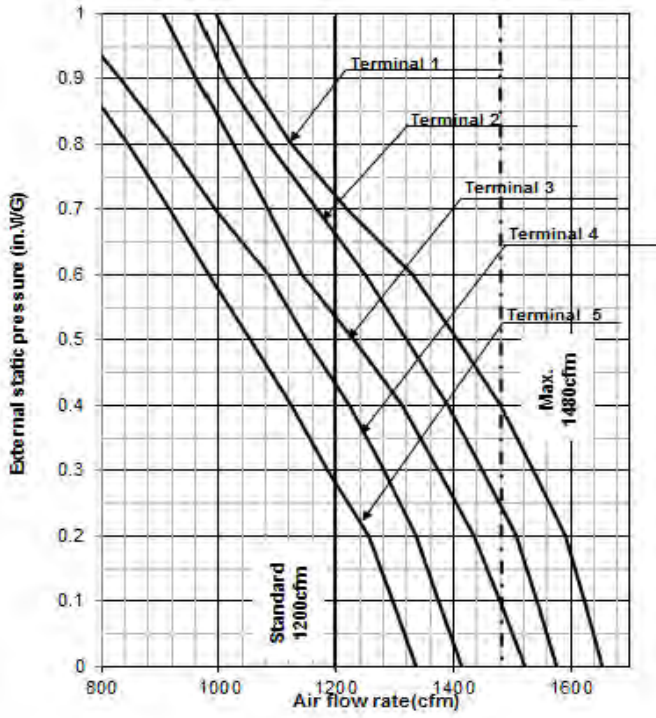

MMD-AP0420VHG2UL

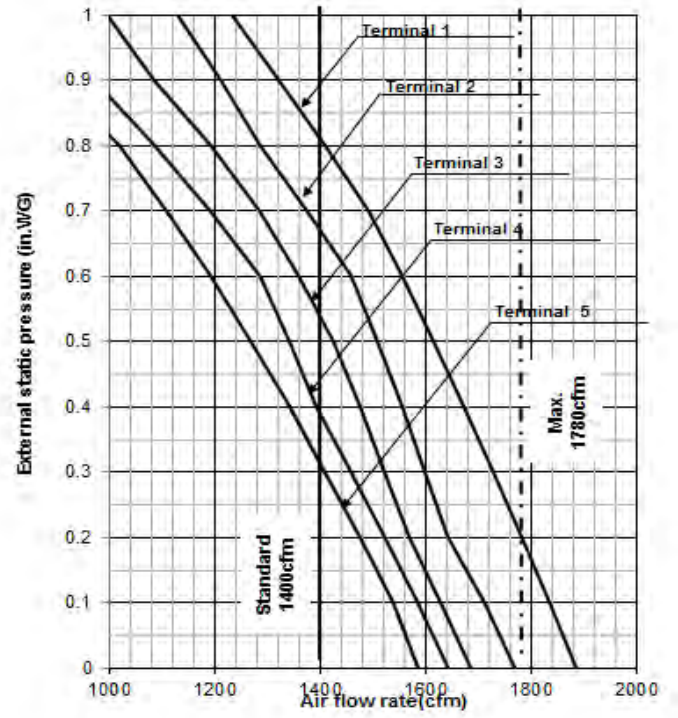

MMD-AP0480VHG2UL

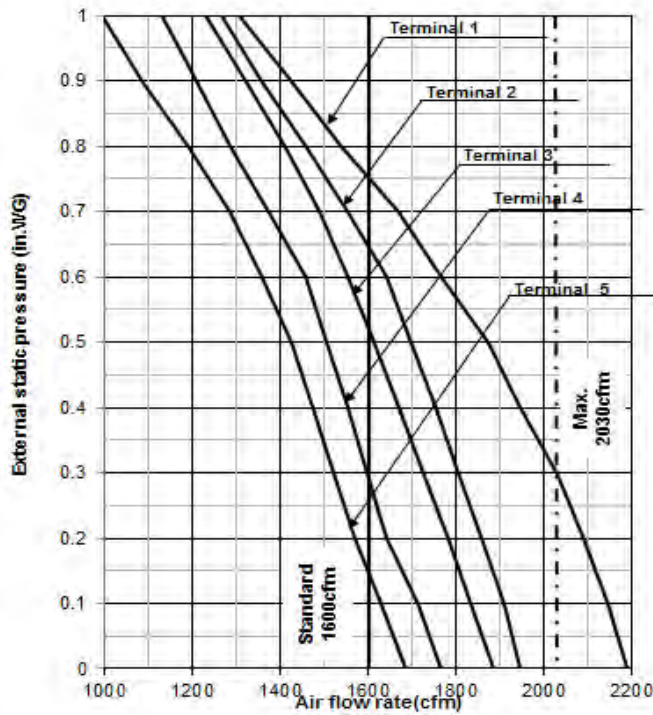

MMD-AP0600VHG2UL

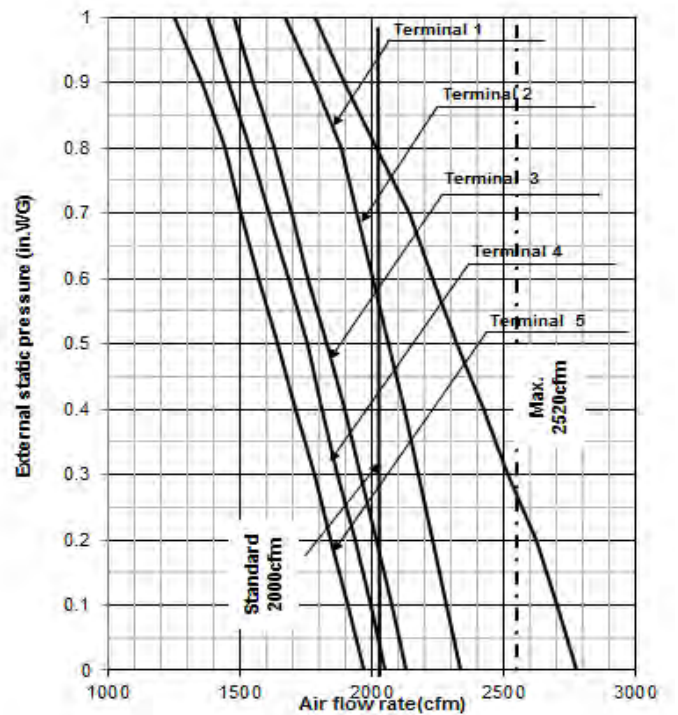

9. Sound data

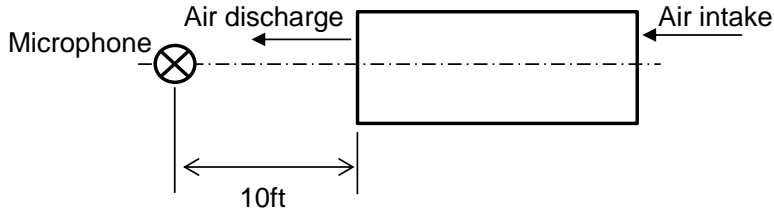

MMD-AP00120VHG2UL

Fan tap	H	M	L
External static Pressure	0.3	0.3	0.3
Sound pressure level dB(A)	41	38	37

MMD-AP0180VHG2UL

Fan tap	H	M	L
External static Pressure	0.5	0.5	0.5
Sound pressure level dB(A)	41	39	38

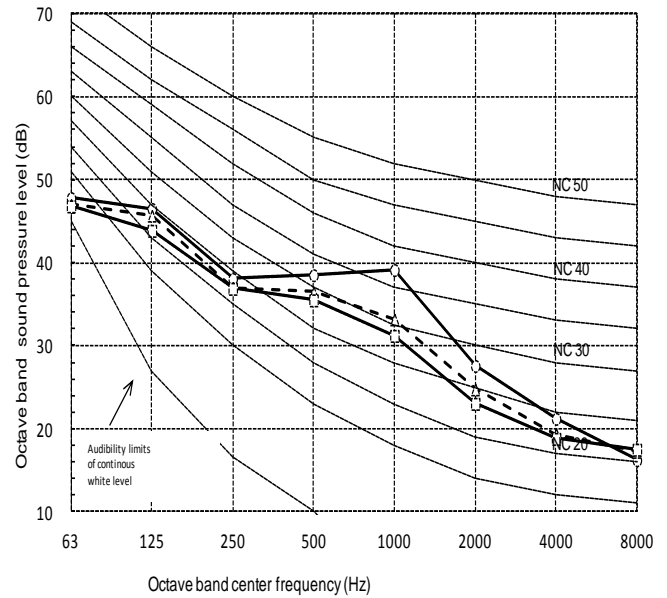
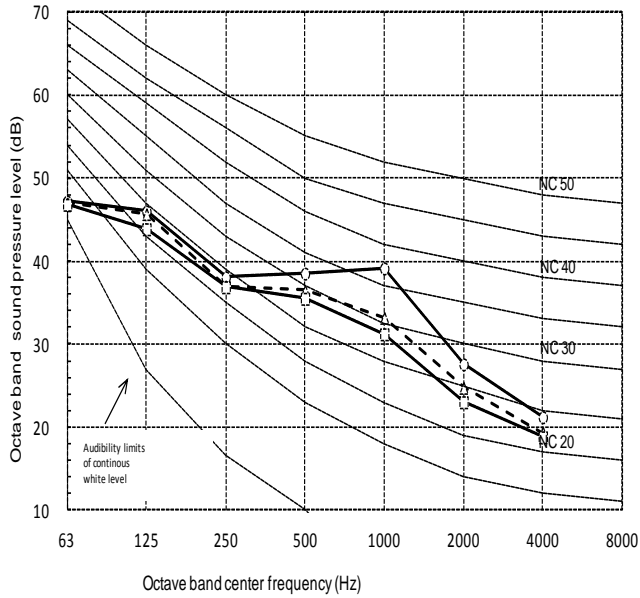

9. Sound data

MMD-AP0240VHG2UL

Fan tap	H	M	L
External static Pressure	0.3	0.3	0.3
Sound pressure level dB(A)	41	39	38

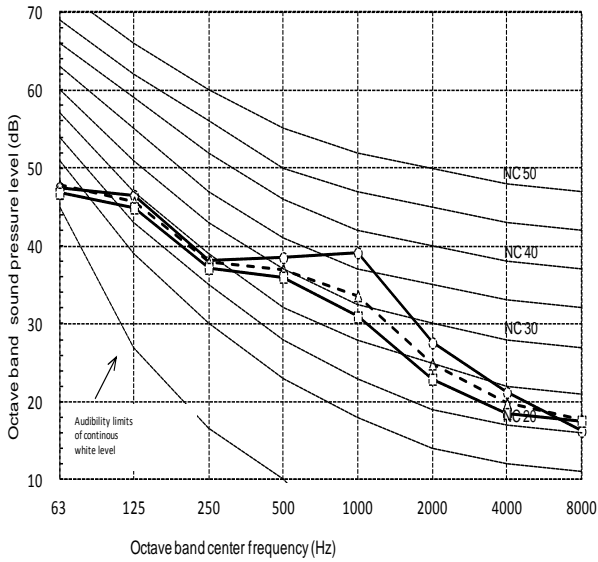

MMD-AP0300VHG2UL

Fan tap	H	M	L
External static Pressure	0.5	0.5	0.5
Sound pressure level dB(A)	43	40	

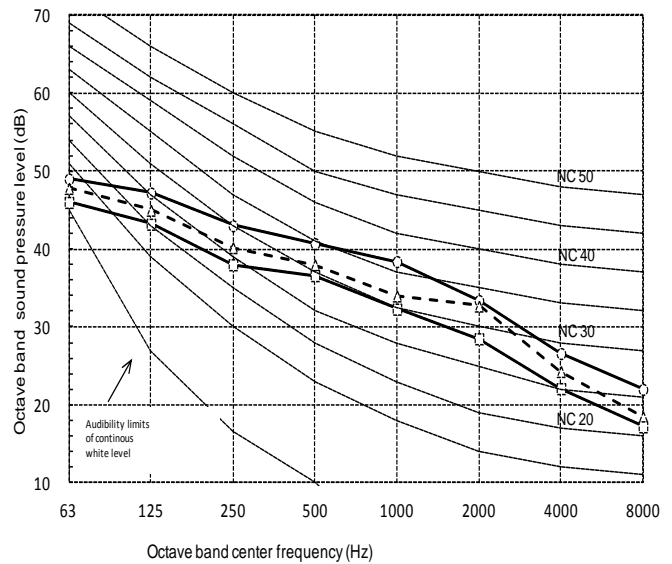

MMD-AP0360VHG2UL

Fan tap	H	M	L
External static Pressure	0.5	0.5	0.5
Sound pressure level dB(A)	45	44	42

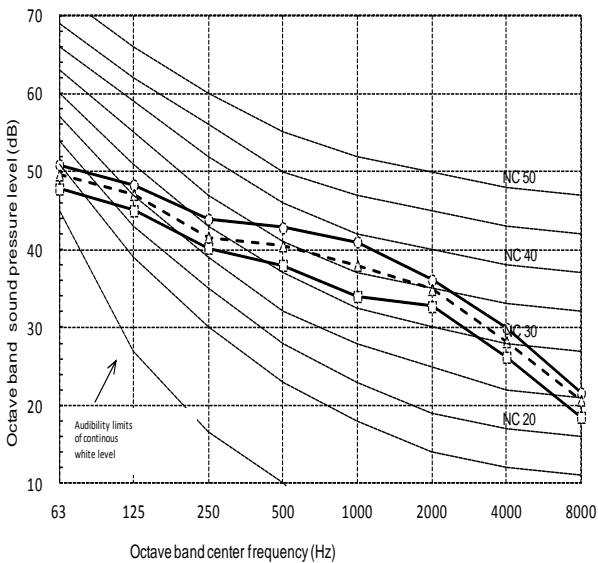

MMD-AP0420VHG2UL

Fan tap	H	M	L
External static Pressure	0.5	0.5	0.5
Sound pressure level dB(A)	46	45	43

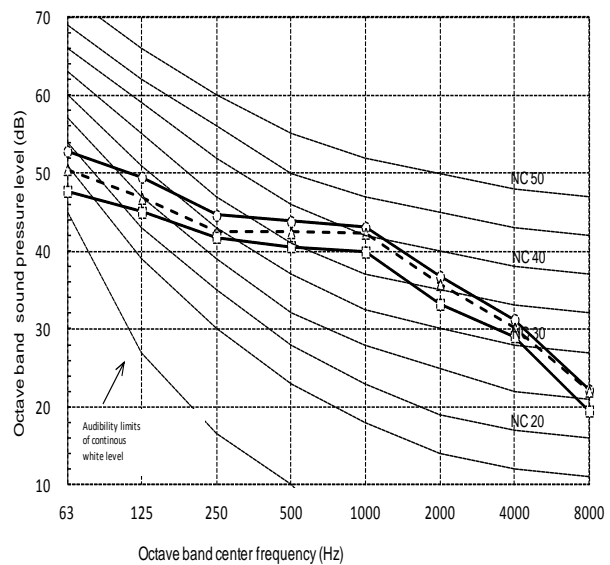

9. Sound data

MMD-AP0480VHG2UL

Fan tap	H	M	L
External static Pressure	0.5	0.5	0.5
Sound pressure level dB(A)	48	47	45

MMD-AP0600VHG2UL

Fan tap	H	M	L
External static Pressure	0.5	0.5 <td>0.5</td>	0.5
Sound pressure level dB(A)	52	51	47

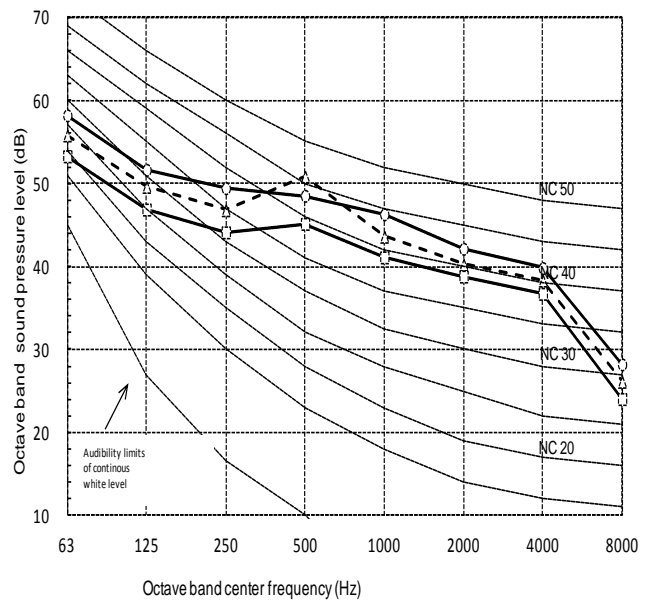
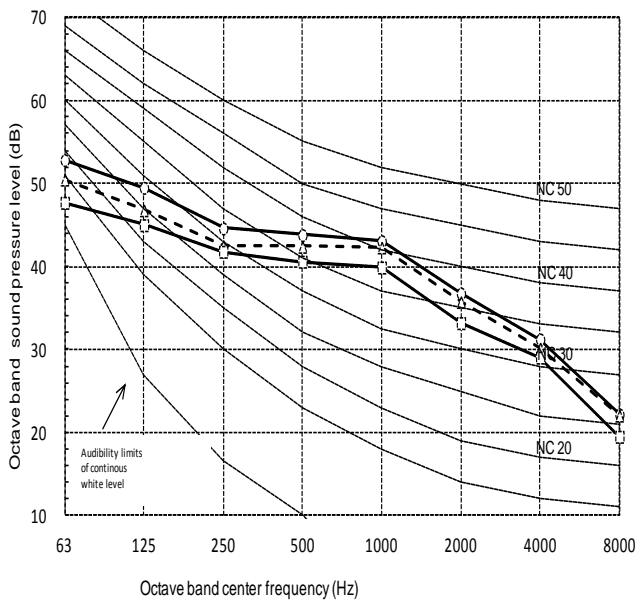

10. Accessories

Product name		Model name	Description
Electric heater (240/208V)	1.0kW/0.8kW	TCB-HT101VDGUL	For 012 to 060 type
	3.0kW/2.3kW	TCB-HT301VDGUL	For 012 to 060 type
	5.0kW/3.8kW	TCB-HT501VDGUL	For 012 to 060 type
	6.0kW/4.5kW	TCB-HT601VDGUL	For 018 to 060 type
	8.0kW/6.0kW	TCB-HT801VDGUL	For 024 to 060 type
	9.5kW/7.1kW	TCB-HT951VDGUL	For 030 to 060 type
Plenum, with 2" MERV8 filter		TCB-PL2S241VDGUL	For 012, 018, 024 type
		TCB-PL2S361VDGUL	For 030, 036 type
		TCB-PL2S481VDGUL	For 042, 048 type
		TCB-PL2S601VDGUL	For 060 type
Filter box, 2" MERV8 filter		TCB-FB2F241VDGUL	For 012, 018, 024 type
		TCB-FB2F361VDGUL	For 030, 036 type
		TCB-FB2F481VDGUL	For 042, 048 type
		TCB-FB2F601VDGUL	For 060 type

[Notes]

1. Plenum has 1/2" fiberglass insulation.
2. 2" filter box has filter rails that can be removed to allow use with 4" filter.
3. Return air grille(s) and duct colloars are field-provided and field-installed.
4. Plenum has return air duct opening on front and right side as standard. Field-changable to front and left side duct opening. Additional opening will require the field cut and modifications.

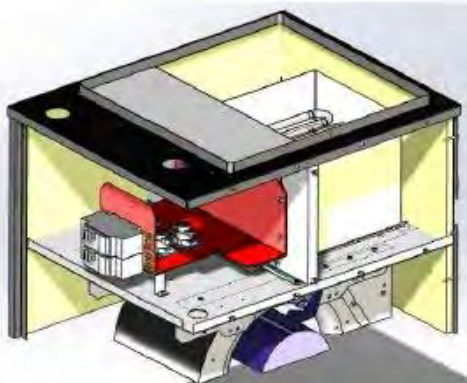

Electric heater

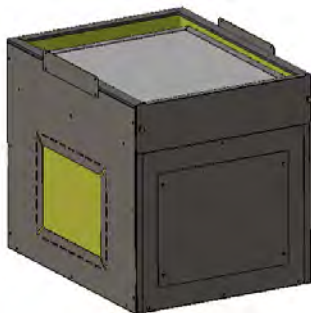

Plenum



Filter box

Vertical Air Handling Unit type Engineering Data Book

Model name :

MMD-AP___0VHG2UL

March, 2018

TOSHIBA CARRIER NORTH AMERICA, Inc.



NOHEA LOTS Bldg 6

Nohea at Mauna Lani

EQUIPMENT SUBMITTAL

ACCU1&FC1

ACCU2 &FC2

4-11-2022

MECHANICAL CONTRACTOR

CUSTOM AIRE (BIG ISLAND AIR CONDITIONING)

73-5620 KAUHOLA STREET - UNIT 6

KAILUA KONA, HI 96740

**MECHANICAL ENGINEER
ENGINEERING PARTNERS, INC.**

455 E LANIKAULA ST

HILO, HI 96720

SUBMITTED BY:

Charles Liang



EQUIPMENT COVERED

ACCU-1: TOSHIBA/CARRIER MODEL MCY-MAP0607HS-UL

- TOSHIBA/CARRIER SINGLE PHASE 5 TON HEAT PUMP
- NOMINAL 60K BTUH COOLING CAPACITY
- 208-230 V/1/60 HZ, R-410A REFRIGERANT
- VARIABLE SPEED INVERTER SCROLL COMPRESSOR
- OPTIONAL AMERON PSX-700 CORROSION RESISTANT PROTECTIVE COATING ON UNIT CABINET
- OPTIONAL BLYGOLD "POLUAL-XT" CORROSION RESISTANT PROTECTIVE COATING ON CONDENSER COIL (3-YEAR LIMITED COATING WARRANTY)

FC1: TOSHIBA/CARRIER MODEL MMD-AP0600VHG2UL

- NOMINAL 60K BTUH COOLING CAPACITY
- T/C VRF CARRIER TOSHIBA/CARRIER VERTICAL AHU
- 208-230V/1 /60 HZ, R-410A REFRIGERANT
- MULTIPOSED UNIT
- DUAL DRAINAGE SPOUTS
- THREE FAN SPEEDS
- ECM FAN MOTOR
- FILTER MERV 3
- (1) RBC-AMS54E-UL, WIRED PROGRAMMABLE TSTAT (FIELD INSTALLED BY CONTRACTOR)



ACCU-2: CARRIER MODEL 24AHA424A003

- CARRIER 24AHA4 PERFORMANCE SERIES AIR COOLED CONDENSING UNIT
- SIZE 24, NOMINAL 2.0 TON COOLING CAPACITY
- 15.5 SEER / 12.5 EER @ AHRI CONDITIONS
- R-410A REFRIGERANT
- 208-230V/1/60HZ
- GALVANIZED STEEL CABINET
- OPTIONAL AMERON PSX-700 CORROSION RESISTANT PROTECTIVE COATING ON UNIT CABINET
- SCROLL COMPRESSORS
- HORIZONTAL DISCHARGE CONDENSER FAN
- COPPER TUBE / ALUMINUM FIN CONDENSER COIL
- OPTIONAL BLYGOLD "POLUAL-XT" CORROSION RESISTANT PROTECTIVE COATING ON CONDENSER COIL (3-YEAR LIMITED COATING WARRANTY)
- FACTORY SUPPLIED FILTER DRIER (FIELD INSTALLED BY

FC2: CARRIER MODEL FV4CNF002L00

- CARRIER FV4C PERFORMANCE SERIES-VARIABLE SPEED FAN COIL UNIT
- SIZE 002, NOMINAL 2 TON COOLING CAPACITY
- 800 CFM SUPPLY AIR @ 0.60" W.G. E.S.P.
- 1/2 HP VARIABLE SPEED ECM FAN MOTOR
- 208-230V/1/60HZ
- R-410A REFRIGERANT
- PAINTED GALVANIZED STEEL CABINET WITH 1-IN. SUPER THICK INSULATION
- 1" THICK, CLEANABLE FILTER
- ALUMINUM TUBE / ALUMINUM FIN DIRECT EXPANSION COIL
- FACTORY INSTALLED THERMAL EXPANSION VALVES (TXV)
- NON-METALLIC CONDENSATE DRAIN PANDC FAN MOTOR
- (1) T-4900, 7-Day Programmable Thermostat (Field Installed by Contractor)

Carrier
Air Conditioning



EXCEPTIONS:

1. Smoke Detector is provided by other.
2. CO2 Sensor is provided by other.
3. 3rd party DDC controls, BACnet control, except as noted above.
4. Pad, spring isolator.
5. UV-C light provided by the contractor.
6. Other HVAC Equipment is provided by other.

Equipment List

Equipment Summary

Type	Description	Model	Qty	Tags
Outdoor Units	1-Phase Heat Pump Series Outdoor Unit	MCY-MAP0607HS-UL	1	ACCU1
Indoor Units	Vertical AHU Type Indoor Unit	MMD-AP0600VHG2UL	1	FCU-1
Controls	Programmable Wired Controller	RBC-AMS54E-UL	1	

Refrigerant Piping Summary

Pipe Size (inch)	Total Length (feet)	Number of Bends
5/8	40	0
3/8	40	0

System 1

Piping Diagram Image (Design View)

Note: Installing Contractor must verify actual piping lengths and update selection file as necessary to check for errors and calculate correct additional refrigerant charge.

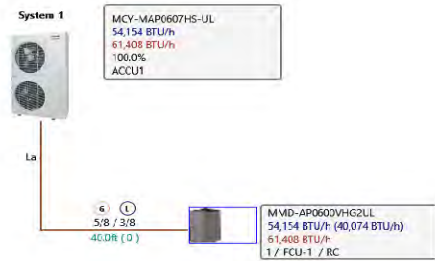

System 1

System Control Wiring Image (Wiring View)

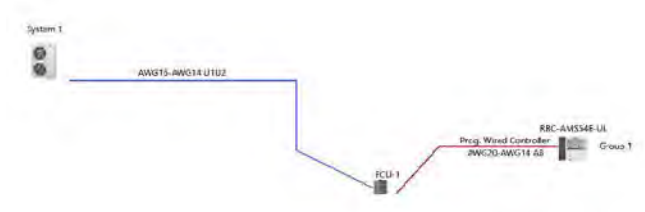

OUTDOOR UNIT SCHEDULE

VRoom Select v2.0.406

System Tag		System 1
Tag Reference		ACCU1
General Data	Make	Toshiba
	Model Number	MCY-MAP0607HS-UL
	Modules	
	Nominal Cooling Capacity (BTU/h)	60,000.0
	Nominal Heating Capacity (BTU/h)	66,000.0
	System Connected Capacity	100.0%
	Main Refrigerant Pipe Dims (inch)	3/4 / 3/8
	Preliminary Added Field Charge (lb)	2.7
	Sound Pressure (dBA)	55 / 58
	Unit Weight (lbs)	311.0
Design Conditions	Project Design Cooling Outdoor Temp DB (°F)	96.0
	Project Design Heating Outdoor Temp WB[or DB] (°F)	16.5
Performance Data	Corrected Cooling Total Capacity (BTU/h)	54,154.2
	Corrected Heating Capacity (BTU/h)	61,408.4
Electrical Data	Voltage / Phase	208/230V / 1-phase 3-wire
	MCA	36.3
	Recommended Fuse Size (RFS) [MOCP]	40
Efficiency Data	Cooling Efficiency IEER[or SEER]/EER	[19.05]/10.9
	Heating COP @ 47°F [or HSPF]	[11.25]
Notes / Options	Applicable System Notes - See Notes Below	1, 2, 3, 4, 5

Notes & Options:

- 1 Nominal cooling capacities are based on indoor air temperature of 80°F DB / 67°F WB, outdoor air temperature of 95°F (DB)
- 2 Nominal heating capacities are based on indoor air temperature of 70°F DB, outdoor air temperature of 47°F DB / 43°F WB
- 3 VRF Efficiency values for EER, IEER, and COP are for mixed ducted and non-ducted indoor units based on AHRI 1230 test method.
- 4 Ductless and Single-Phase VRF Heat Pump Efficiency values for EER, SEER, and HSPF are for mixed ducted and non-ducted indoor units based on AHRI 210/240 test method.
- 5 Preliminary Additional Field Charge is calculated based on software inputs; Final Additional Field Charge must be calculated based on final "as-built" piping dimensions.

INDOOR UNIT SCHEDULE

VRoom Select v2.0.406

System Tag		System 1
Tag Reference		FCU-1
General Data	Room Name	
	Make	Toshiba
	Model	MMD-AP0600VHG2UL
	Type	Vertical AHU Type
	Nominal Cooling Capacity (BTU/h)	60,000.0
	Nominal Heating Capacity (BTU/h)	67,000.0
	Refrig Pipe Dimensions (inch)	5/8 / 3/8
Design Conditions	Project Cooling Design Entering Temp DB/WB (°F)	73.4 / 63.1
	Project Heating Design Entering Temp DB (°F)	70.0
Performance Data	Cooling Total Capacity (BTU/h)	54,154.2
	Cooling Sensible Capacity (BTU/h)	40,074.1
	Heating Capacity (BTU/h)	61,408.4
	Estimated Cooling Coil LAT (°F)	54.0
	Estimated Heating Coil LAT (°F)	99.5
Electrical Data	Voltage / Phase	208/230V / 1-phase
	MCA / MOCP	9.5 / 15
Fan Data	Selected Fan Speed	High
	Rated Airflow at Selected Fan Speed (cfm)	2000
	Max Fan ESP Setting (IN WG)	0.1/0.5/0.8
	Sound Pressure Per Fan Speed (H/M/L) (dBA)	52/51/47
Remote Controller	Zone Remote Controller 1	RBC-AMS54E-UL
	Zone Remote Controller 2	
	ERV (DI/DO) Interface Model Number	
Notes / Options	Applicable System Notes - See Notes Below	1, 2, 3, 4, 5

Notes & Options:

- 1 Nominal cooling capacities are based on indoor air temperature of 80°F DB / 67°F WB, outdoor air temperature of 95°F (DB)
- 2 Nominal heating capacities are based on indoor air temperature of 70°F DB, outdoor air temperature of 47°F DB / 43°F WB
- 3 LATs estimated using formula for sensible capacity = (1.08 Btu/(hr cfm °F)) x cfm x deltaT
- 4 All ductless FMA/FMC/FMU or FV4 series indoor units require a piping adaptor kit (Model #: 331831-701 or 40MD000003)
- 5 Warning: Accessories are filtered by system and unit type. Check product data to confirm accessory compatibility with voltage, product tier, etc.
- 6 Warning: One or more outside air indoor units in this system have cooling or heating temperatures that are out of range.

SSMS-e Single VRF Outdoor Unit MCY-MAP0607HS-UL—Heat Pump

TOSHIBA
Carrier

ACCU-1

Submittal Data

Job Data _____ Location _____
 Buyer _____ Buyer PO # _____ Carrier # _____
 Unit Number _____ Model Number _____
 Performance Data Certified By _____ Date _____



SSMS-e VRF Heat Pump Features

- 3, 4, and 5-ton single-phase modules available
- Modules have inverter-driven twin rotary compressor
- 591 ft (180 m) actual total system piping (liquid line)
- 328 ft (100 m) actual piping length from outdoor unit to furthest fan coil
- Up to 330 ft (100 m) control wiring between outdoor units
- Up to 6560 ft (2000 m) control wiring between the outdoor units and indoor units
- Operating temperature range Cooling (db): 23 to 122 F (–5 to 50 C)
- Heating (wb): –13 to 60 F (–25 to 15.6 C)
- Protection: high pressure sensor and switch, low pressure sensor, process controller board fuse, inverter overload protection
- 7-year compressor limited warranty, 5-year parts limited warranty

Header Unit Model		MCY-MAP0607HS-UL
PERFORMANCE		
Nominal Cooling Capacity	Btu/h	60,000
Nominal Heating Capacity	Btu/h	66,000
Maximum Total Connected Indoor Unit Capacity		Up to 135%
COOLING EFFICIENCY†		
SEER, Ducted FCUs	Btu/Wh	17.60
SEER, Ductless FCUs	Btu/Wh	20.50
HEATING EFFICIENCY†		
HSPF, Ducted FCUs		11.00
HSPF, Ductless FCUs		11.50
Fan Type (Qty)		Propeller (2)
Airflow	CFM	4850
Combined System Sound Pressure, Cooling/Heating	dBA	55.0/58.0
ELECTRICAL		
Power Supply	V/Ph/Hz	208-230/1/60
Minimum Circuit Amps (MCA)	A	36.3
Recommended Fuse Size	A	40

COMPRESSORS		
Type (Number)		Hermetic Twin Rotary (1)
Motor Output	kW	3.75
FAN MOTOR		
Motor Type (Steps)		Propeller Fan (2)
Motor Output	kW	0.10 + 0.10
PHYSICAL DATA		
Pipe Connection Size - Liquid (High Pressure)	in.	3/8 (Flare)
Pipe Connection Size - Gas (Low Pressure)	in.	3/4 (Flare)
Refrigerant		R-410A
Factory Charge††	lb	14.8
External Finish		Munsell 1Y8.5/0.5
Unit Width	in.	39.8
Unit Height	in.	61.0
Unit Depth	in.	14.6
Unit Net Weight	lb	311

LEGEND

db — Dry Bulb
 SEER — Seasonal Energy Efficiency Ratio
 FCU — Fan Coil Unit
 HSPF — Heating Seasonal Performance Factor
 wb — Wet Bulb

†Rated per AHRI (Air-Conditioning, Heating and Refrigeration Institute) 1230 Standard.

Cooling: Indoor 80°F (27°C) db/67°F (20°C) wb; Outdoor 95°F (35°C) db

Heating: Indoor 70°F (21°C) db; Outdoor 47°F (8°C) db/43°F (6°C) wb

††Additional charge required.

Manufacturer reserves the right to discontinue, or change at any time, specifications or designs without notice and without incurring obligations.

OUTDOOR UNIT HEAT PUMP MCY-MAP0607HS-UL DIMENSIONAL DRAWING

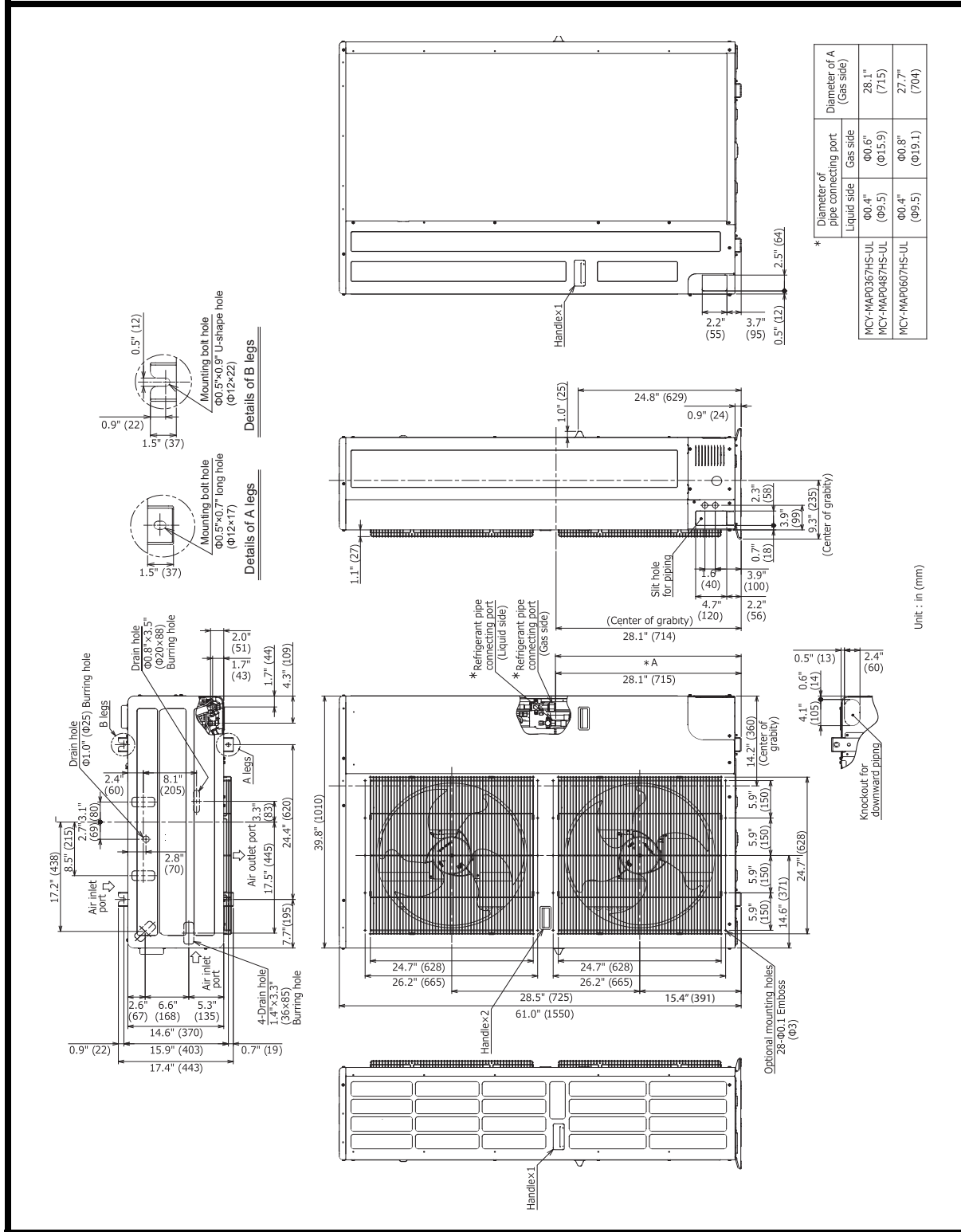

© Carrier Corporation 2017

Manufacturer reserves the right to discontinue, or change at any time, specifications or designs without notice and without incurring obligations.
 Printed in U.S.A. Form MCY-MAP0607HS-UL_01 Pg 2 1-17 Replaces: NEW

SMMSe/SHRMe VRF Indoor Unit MMD-AP0600VHG2UL / Vertical Air Handler



FC-1

Submittal Data

Job Name _____ Location _____

Tag _____



STANDARD FEATURES

- Dual Drainage Spouts
- Three Fan Speeds - High, Medium and Low
- Unit Can Be Installed Standing Vertical or Laid Horizontally
- Electronically Commutated Fan Motor (ECM)
- Built In Pulse Modulating Valve For Installation Ease
- Removable Front Panel Provides Easy Access
- Filter MERV3

INDOOR UNIT MODEL	MMD-AP0600VHG2UL	
PERFORMANCE		
Cooling Rated Capacity	Btu/h	60,000
Heating Rated Capacity	Btu/h	67,000
Airflow (H / M / L)	CFM	2000 / 1830 / 1640
Sound Data (H / M / L)†	dBA	51.01 / 50.97 / 46.98
External Static Pressure (ESP)	in. WG	0.5 (Factory Default)
		0.8 (Max.)
ELECTRICAL		
Power Supply	V/Ph/Hz	208-230/1/60
MCA*	A	9.5
MOCP*	A	15
Full Load Amps (FLA)	A	7.6

PHYSICAL DATA		
Pipe Connection Size - Liquid	inches	3/8 (brazed)
Pipe Connection Size - Suction	inches	5/8 (brazed)
Pipe Connection Size - Drain	inches	3/4 (FTP)
Refrigerant	R410A	
DIMENSIONS (inches)	H (in)	57-7/8
	W (in)	24-1/4
	D (in)	31-1/4
NET WEIGHT	lbs	253

ACCESSORIES (Optional)

- Wired Remote Controller (7-Day Programmable) - RBC-AMS54E-UL
- Simple Wired Remote Control - RBC-AS41UL
- Stand Alone Receiver with Wireless Remote TCB-AX32UL
- Remote Sensor TCB-TC41LUL
- Wired Remote Controller - RBC-AMT32UL
- Filter Box / 2*MERV8 (TCB-FB2F601VDGUL)
- Plenum TCB-PL2S601VDGUL
- Electrical Heater (240V/208V):

NOTES:

- * Does not include electric heaters.
- † Average / weighted sound values.

1.0kW/0.8kW	TCB-HT101VDGUL
3.0kW/2.3kW	TCB-HT301VDGUL
5.0kW/3.8kW	TCB-HT501VDGUL
6.0kW/4.5kW	TCB-HT601VDGUL
8.0kW/6.0kW	TCB-HT801VDGUL
9.5kW/7.1kW	TCB-HT951VDGUL

Dimensional Drawing Indoor Unit Vertical Air Handler MMD-AP0600VHG2UL

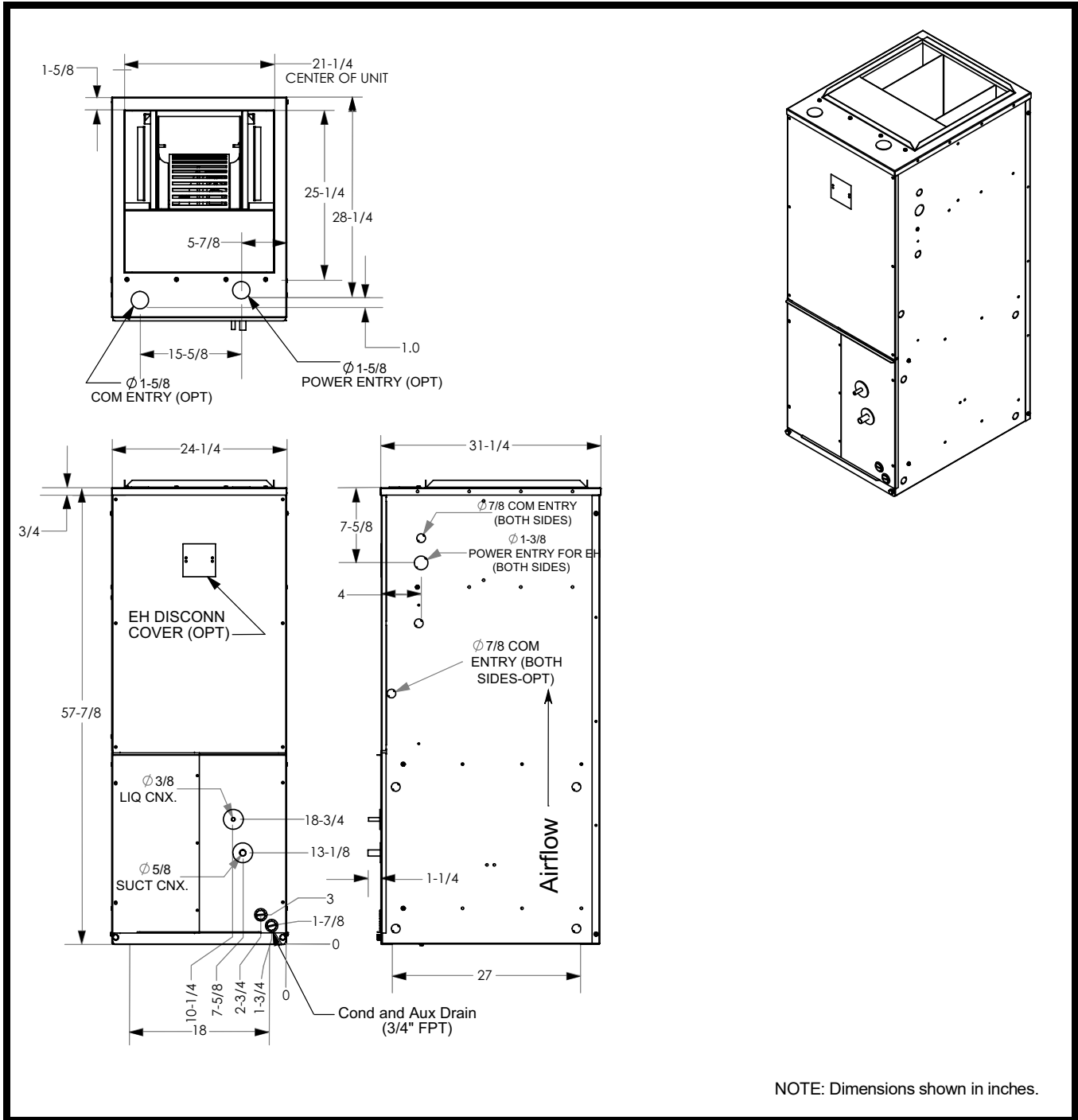

Submittal Data

Job Data _____ Location _____
Buyer _____ Buyer PO # _____ Carrier # _____
Unit Number _____ Model Number _____
Performance Data Certified By _____ Date _____

FC-1



SMMSe / SHRMe VRF Wired Remote Controller Features

- Group control up to 8 indoor units
- Mode of operation
- Fan speed control
- ON/OFF
- Set temperature range limit
- Dual set point (HR only)
- Schedule weekly timer
- Clock setting
- Temperature display in 1°F
- Individual louver control
- Back lit
- Multiple languages
- DN code setting
- Compatible with Toshiba Carrier VRF and RAV systems

DIMENSIONAL DRAWING

WIRED REMOTE CONTROLLER RBC-AMS54E-UL

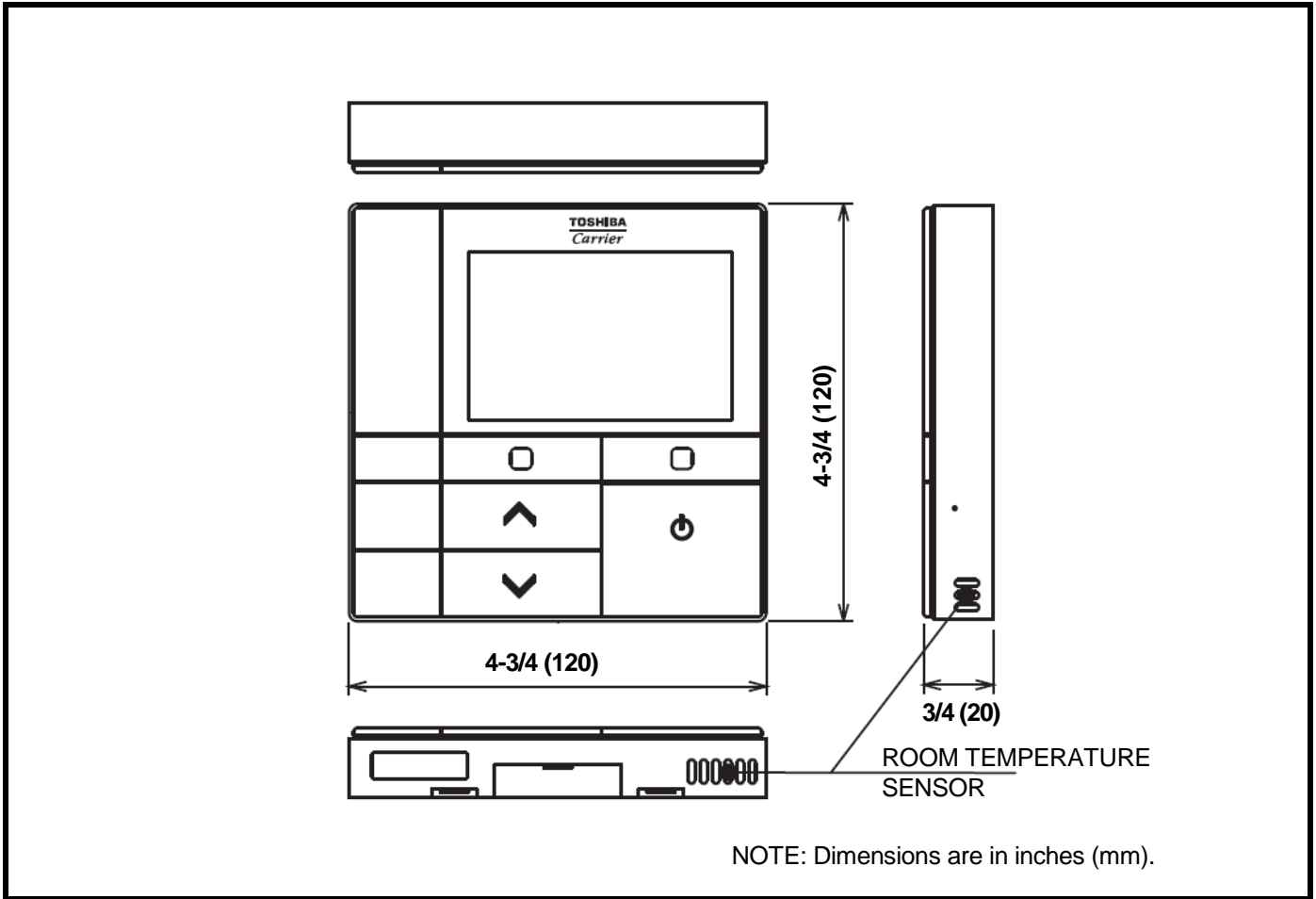

WIRING DIAGRAM

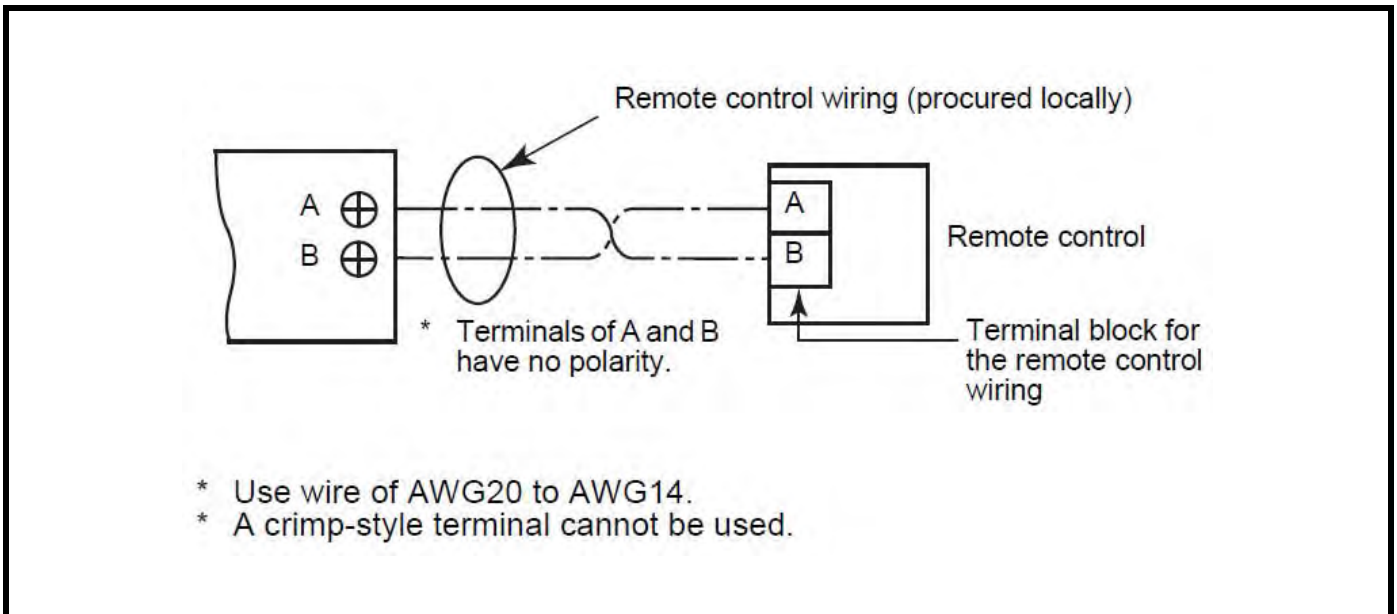

Unit Report For 2T

Project: **Nohea Residence LOT 6**
 Prepared By:

04/11/2022

ACCU2 & FC2



Outdoor Unit Parameters

Unit Model:..... **24AHA**
 Unit Size:..... **2 Tons (Size 24)**
 Voltage:..... **208/230-1-60** V-Ph-Hz

Indoor Coil Parameters

Unit Model:..... **FV4C**
 Unit Size:..... **Size 002 (18 - 36,000 Btuh)**
 Cabinet Insulation: **Single-piece cabinet with 1-in. super thick insulation**
 Voltage:..... **208-1-60** V-Ph-Hz
 Refrigerant Type:..... **Puron**
 Heating Size:..... **No Heat**

Outdoor Unit Dimensions and Weight

Unit Length:..... **36.9375** in
 Unit Width:..... **14.5625** in
 Unit Height:..... **31.125** in
 Unit Shipping Weight:..... **168.** lb

Indoor Coil Dimensions and Weight

Unit Length:..... **22.0625** in
 Unit Width:..... **17.625** in
 Unit Height:..... **42.6875** in
 Unit Shipping Weight:..... **135.** lb

RESIDENTIAL APPLICATIONS

This warranty is to the original purchasing owner and subsequent owners only to the extent and as stated in the Warranty Conditions and below. The limited warranty period in years, depending on the part and the claimant, is as shown in the table below.

Limited Warranty (Years)		
Item	Original Owner	Subsequent Owner
Parts	10* (or 5)	5
Compressor	10* (or 5)	5

*If properly registered within 90 days of original installation, otherwise 5 years (except in California and Quebec and other jurisdictions that prohibit warranty benefits conditioned on registration). See Warranty Conditions below.

OTHER APPLICATIONS

The warranty period is five (5) years on the compressor, and one (1) year on all other parts. The warranty is the original owner only and is not available for subsequent owners.

Ordering Information

Part Number	Description	Quantity
Outdoor Unit		
24AHA424A003	Performance Series Air Conditioner with Puron 2 Tons Cooling 14 SEER @ ARI Conditions	1
Indoor Coil		
FV4CNF002L00	FV4C Performance Series Fan Coil with Puron 2 Tons Cooling 208/230-1-60 Single-piece cabinet with 1-in. super thick insulation Aluminum	1

The Product and Ratings Data in this program is subject to change at any time and without notice. Please refer to the latest product literature and the AHRI directory at www.ahridirectory.org for the most up-to-date information.

Performance Summary For 2T

Project: Nohea Residence LOT 6
Prepared By:

04/11/2022

System Performance

System:	24AHA/FV4C	Actual Clg Airflow:.....	800.0	CFM
System Quantity:.....	1	Standard Clg Airflow:.....	800.0	CFM
Altitude:.....	0.0 ft	Total Net Clg Capacity:.....	22.16	MBH
Linear Pipe Length:.....	0.0 ft	Net Sensible Clg Capacity:.....	16.37	MBH
SEER @ ARI Conditions:.....	15.5	Total System Power:.....	1.85	kW
EER @ ARI Conditions:.....	12.5			

System Parameters

Outdoor Unit Parameters

Unit Model:.....	24AHA424A003
Unit Size (Nominal):.....	2 Tons (Size 24)
Voltage:.....	208/230-1-60 V-Ph-Hz
Clg Ent Air DB Ambient:.....	95.0 °F

Indoor Coil Parameters

Unit Model:.....	FV4CNF002L00
Unit Size (Nominal):	Size 002 (18 - 36,000 Btuh)
Voltage:.....	208-1-60 V-Ph-Hz
Ent Air DB:.....	74.00 °F
Ent Air WB:.....	63.60 °F
Ent Enthalpy:.....	28.87 BTU/lb
Lvg Air DB:.....	55.05 °F
Lvg Air WB:.....	54.27 °F
Lvg Enthalpy:.....	22.72 BTU/lb
Heating Size (Nominal):	No Heat
Total External Static Pressure:.....	0.60 in wg
Clg Coil Note:	***Airflow adjusted to high (400 cfm/ton).

Electrical Data

Outdoor Electrical Data

Unit Voltage:.....	208/230-1-60 V-Ph-Hz
Fan Motor FLA:.....	0.50 Amps
MCA:.....	14.1 Amps
Max Fuse:.....	25 Amps
Operating Range Min:.....	197 V
Operating Range Max:.....	253 V
Compressor RLA:.....	10.9 Amps
Compressor LRA:.....	62.9 Amps

Indoor Electrical Data:

(For units with no factory installed electric heaters)

Unit Voltage:.....	208-1-60 V-Ph-Hz
Unit FLA:.....	4.3 Amps
Unit MCA:.....	5.4 Amps
Unit MOCP:.....	15.0 Amps
Unit Min Wire Size:.....	14.0
Unit Fuse/Ckt Bkr Amps:.....	15.0 Amps
Motor HP:.....	1/2 HP

Notice: Indoor Elect. data is for 208-1-60 voltage

The Product and Ratings Data in this program is subject to change at any time and without notice. Please refer to the latest product literature and the AHRI directory at www.ahridirectory.org for the most up-to-date information.

Acoustic Summary For 2T

Project: Nohea Residence LOT 6
Prepared By:

04/11/2022

Outdoor Unit Parameters:

Unit Model:..... **24AHA**
Unit Size:..... **2 Tons (Size 24)**
Variations:..... **Standard**

Octave Band Center Frequency, Hz	125	250	500	1k	2k	4k	8k	dBA
Sound Power,dB	50.5	58.5	60.5	59.5	56.5	51.0	41.5	
A-Weighted Sound Power, dBA								66.0

Indoor Coil Parameters:

Unit Model:..... **FV4C**
Unit Size:..... **Size 002 (18 - 36,000 Btuh)**
Cabinet Insulation:..... **Single-piece cabinet with 1-in. super thick insulation**

Octave Band Center Frequency, Hz	63	125	250	500	1k	2k	4k
Sound Power,dB	67.0	63.0	59.0	56.0	54.0	52.0	48.0

The Product and Ratings Data in this program is subject to change at any time and without notice. Please refer to the latest product literature and the AHRI directory at www.ahridirectory.org for the most up-to-date information.

Certified Drawing For 2T

Project: Nohea Residence LOT 6
Prepared By:

04/11/2022

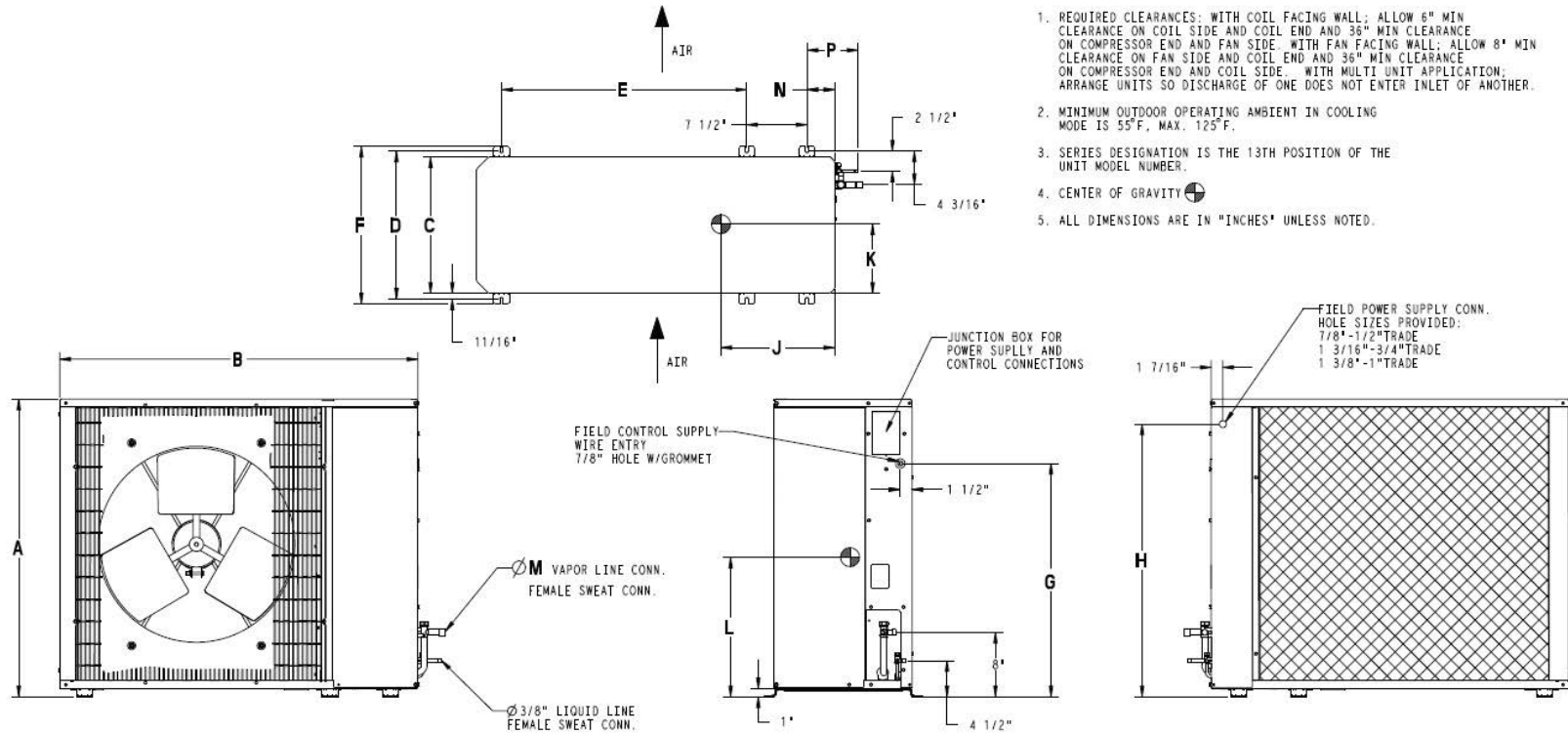

1. REQUIRED CLEARANCES: WITH COIL FACING WALL; ALLOW 6" MIN CLEARANCE ON COIL SIDE AND COIL END AND 36" MIN CLEARANCE ON COMPRESSOR END AND FAN SIDE. WITH FAN FACING WALL; ALLOW 8" MIN CLEARANCE ON FAN SIDE AND COIL END AND 36" MIN CLEARANCE ON COMPRESSOR END AND COIL SIDE. WITH MULTI UNIT APPLICATION; ARRANGE UNITS SO DISCHARGE OF ONE DOES NOT ENTER INLET OF ANOTHER.
2. MINIMUM OUTDOOR OPERATING AMBIENT IN COOLING MODE IS 55°F, MAX. 125°F.
3. SERIES DESIGNATION IS THE 13TH POSITION OF THE UNIT MODEL NUMBER.
4. CENTER OF GRAVITY
5. ALL DIMENSIONS ARE IN "INCHES" UNLESS NOTED.

Outdoor Model

Unit Model:.....**24AHA**
 Unit Size:.....**2 Tons (Size 24)**
 Voltage:.....**208/230-1-60** V-Ph-Hz
 SEER:.....**14**
 PartNumber:.....**24AHA424A003**

Shipping Dimensions and Weights	Outdoor Unit
Height	34.13 in
Width	18.00 in
Length	42.94 in
Operating Weight	148. lb
Shipping Weight	168. lb

Dimensions											
A	B	C	D	E	F	G	K	L	M	N	P
31.13 in	36.94 in	14.56 in	16.00 in	23.44 in	17.19 in	23.13 in	6.75 in	11.63 in	0.75 in	2.88 in	5.81 in

The Product and Ratings Data in this program is subject to change at any time and without notice. Please refer to the latest product literature and the AHRI directory at www.ahridirectory.org for the most up-to-date information.

Certified Drawing For 2T

Project: Nohea Residence LOT 6
Prepared By:

04/11/2022

UNIT CONNECTION SIZES

SUCTION: 018 & 024 - 5/8" I.D. SWEAT
030 & 036 - 3/4" I.D. SWEAT
042 THRU 060 - 7/8" I.D. SWEAT
LIQUID: 3/8" I.D. SWEAT
CONDENSATE: 3/4" FPT

NOTE:

- SERIES DESIGNATION IS THE 14TH POSITION OF UNIT PRODUCT NUMBER
- ALL DIMENSIONS ARE IN "INCHES" UNLESS NOTED.

NOTE: ALLOW 21" FROM FRONT FOR SERVICE

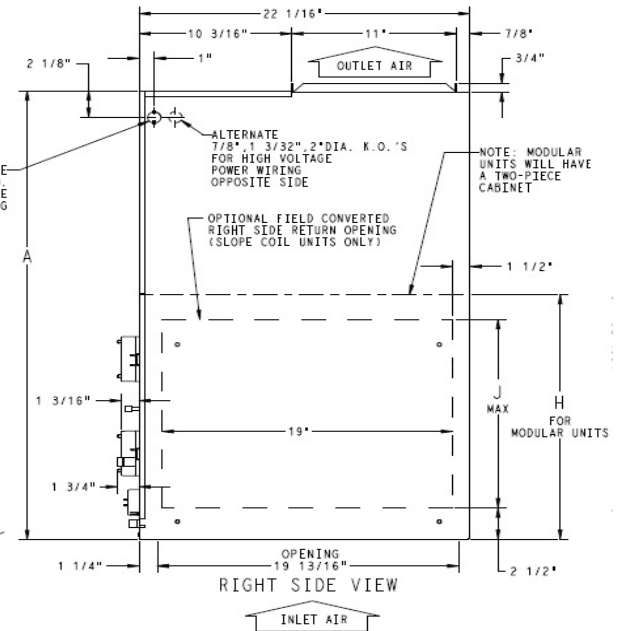
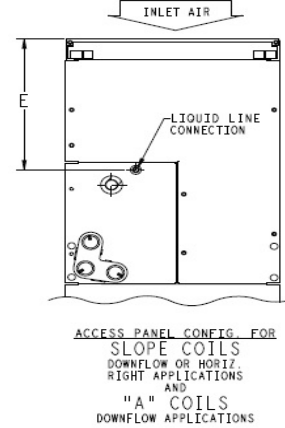
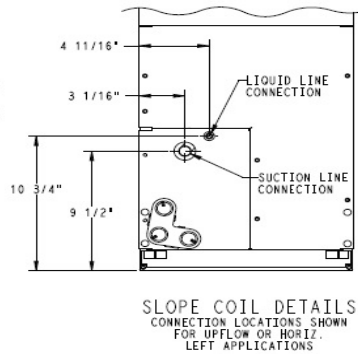
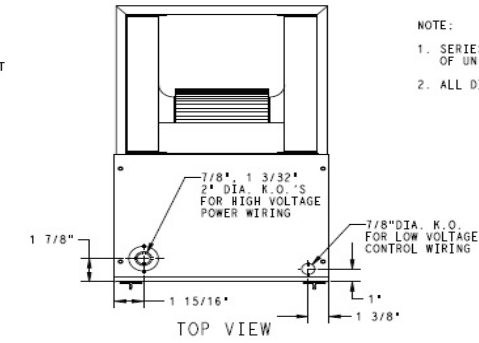
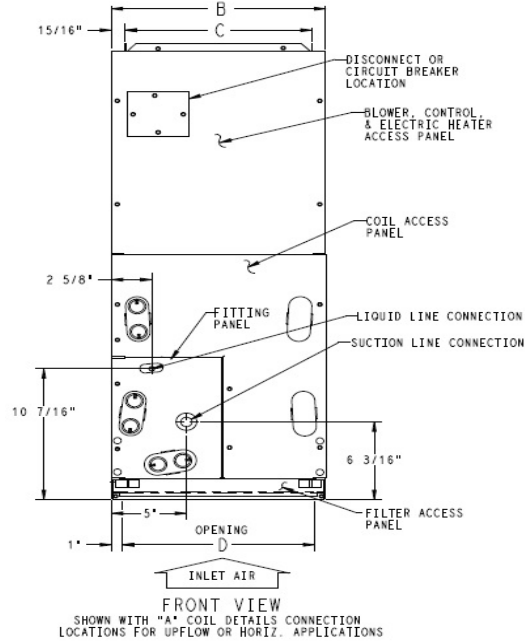

Indoor Coil

Unit Model:..... **FV4C**
Unit Size:..... **Size 002 (18 - 36,000 Btuh)**
Voltage:..... **208-1-60** V-Ph-Hz
Cabinet Insulation: **Single-piece cabinet with 1-in. super thick insulation**
PartNumber:..... **FV4CNF002L00**

Dimensions and Weights		Indoor Coil
Height		42.69 in
Width		17.63 in
Length		22.06 in
Shipping Weight		135. lb

Dimensions									
A	B	C	D	E	F	G	H	J	
42.69 in	17.63 in	15.75 in	15.63 in	10.75 in	--	--	--	--	--

The Product and Ratings Data in this program is subject to change at any time and without notice. Please refer to the latest product literature and the AHRI directory at www.ahridirectory.org for the most up-to-date information.

Certified Drawing For 2T

Project: Nohea Residence LOT 6
 Prepared By:

04/11/2022

* HORIZONTAL MOUNT LOCATIONS - DIMPLES PROVIDED IN TOP PANEL, AND BACK OF CABINET. IN CABINET BOTTOM, HOLES PROVIDED .136" DIA. HORIZONTAL HANGING HARDWARE TO BE FIELD SUPPLIED.

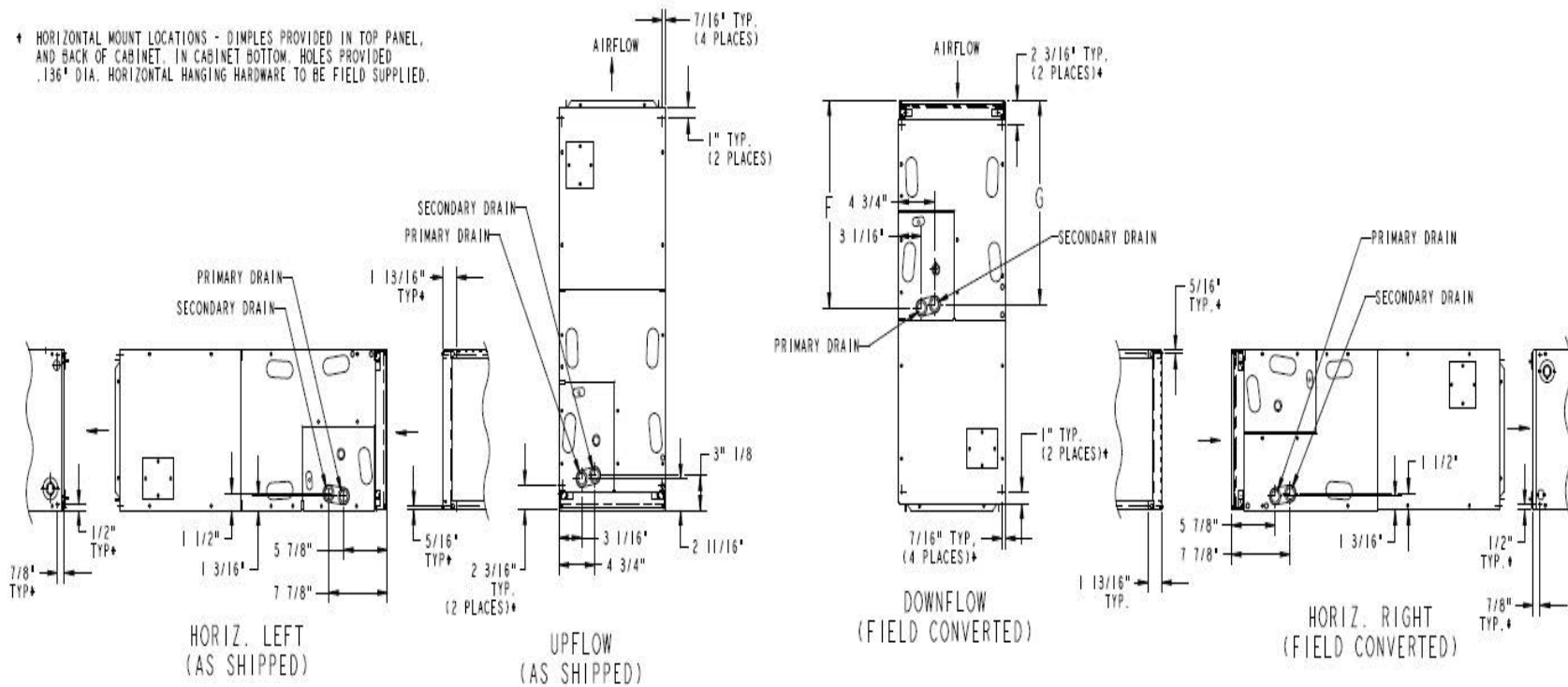

A-COIL

Indoor Coil

Unit Model:..... **FV4C**
 Unit Size:..... **Size 002 (18 - 36,000 Btuh)**
 Voltage:..... **208-1-60** V-Ph-Hz
 PartNumber:..... **FV4CNF002L00**

The Product and Ratings Data in this program is subject to change at any time and without notice. Please refer to the latest product literature and the AHRI directory at www.ahridirectory.org for the most up-to-date information.



Product Data



Fig. 1 — 24AHA4 Unit

NOTE: Images are for illustration purposes **only**. Actual models may differ slightly.

Carrier air conditioners with **Puron**® refrigerant provide a collection of features unmatched by any other family of equipment. The 24AHA4 has been designed utilizing Carrier's **Puron**® refrigerant. This environmentally sound refrigerant allows you to make a responsible decision in the protection of the earth's ozone layer.

NOTE: Ratings contained in this document are subject to change at any time. Always refer to the AHRI directory (www.ahridirectory.org) for the most up-to-date ratings information.

TABLE OF CONTENTS

INDUSTRY LEADING FEATURES / BENEFITS	1
MODEL NUMBER NOMENCLATURE	2
PHYSICAL DATA	2
REFRIGERANT PIPING LENGTH LIMITATIONS	3
VAPOR LINE SIZING AND COOLING CAPACITY LOSS	5
ACCESSORIES	6
ELECTRICAL DATA	8
DIMENSIONS-ENGLISH	9
DIMENSIONS-SI	10
TESTED AHRI COMBINATION RATINGS*	11
DETAILED COOLING CAPACITIES	12
CONDENSER ONLY RATINGS	15
GUIDE SPECIFICATIONS	17
PRODUCTS	17

INDUSTRY LEADING FEATURES / BENEFITS

Energy Efficiency

- 14 SEER/11.7 - 12.2 EER

(Based on tested combinations)

Sound

- Levels as low as 66 dBA

Design Features

- Small footprint
- WeatherArmor cabinet
 - All steel cabinet construction
 - Mesh coil guard

Reliability, Quality and Toughness

- Scroll compressor
- Factory-supplied filter drier
- High pressure switch
- Line lengths up to 250ft (76.2 m)
- Low ambient operation (down to -20°F/-28.9°C with low ambient accessories)

MODEL NUMBER NOMENCLATURE

1	2	3	4	5	6	7	8	9	10	11	12	13
N	N	A	A	A/N	N	N	N	A/N	A/N	A/N	N	N
2	4	A	H	A	4	1	8	A	0	0	3	0
Product Series	Product Family	Product Type	Major Series	SEER	Cooling Capacity			Variations	Open	Open	Voltage	Minor Series
24 = AC	A = AC	H = Horizontal Discharge		4 = 14 SEER				A = Standard	0 = Not Defined	0 = Not Defined	3=208/ 230-1 5=208/ 230-3 6=460/3	0, 1, 2...



Use of the AHRI Certified TM Mark indicates a manufacturer's participation in the program. For verification of certification for individual products, go to www.ahridirectory.org.

PHYSICAL DATA

UNIT SIZE-SERIES	18-30	24-30	30-30	36-30, 50, 60	48-30, 50, 60	60-30, 50, 60
Compressor Type	Scroll					
REFRIGERANT	Puron® (R-410A)					
Charge lb (kg)	6.40 (2.90)	6.50 (2.95)	8.60 (3.90)	8.90 (4.04)	9.00 (4.08)	10.60 (4.81)
Cond Fan	Propeller Type, Direct Drive					
Air Discharge	Horizontal					
Air Qty (CFM)	1285	1285	1900	2615	2615	2785
Motor HP	1/12	1/12	1/10	1/4	1/4	1/4
Motor RPM	800	800	800	800	800	800
Cond Coil						
Face Area (Sq ft)	7.3	7.3	12.1	12.1	12.1	14.1
Fins per In.	20	20	20	20	20	20
Rows	2	2	2	2	2	2
Circuits	3	3	3	3	3	4
Valve Connect. (In. ID)						
Vapor	5/8	3/4	3/4	7/8	7/8	7/8
Liquid	3/8					
Refrigerant Tubes* (In. OD)						
Rated Vapor*	5/8	3/4	3/4	7/8	7/8	1 1/8
Max Liquid Linet†	3/8					

* Units are rated with 25 ft. (7.6 m) of lineset length. Review the VAPOR LINE SIZING AND COOLING CAPACITY LOSS section when using other lineset sizes and lengths of lineset.

Note: Review the unit's Installation Instructions for proper installation guidance.

†Liquid Line Sizing For Cooling Only Systems with Puron® Refrigerant tables.

REFRIGERANT PIPING LENGTH LIMITATIONS

Liquid Line Sizing and Maximum Total Equivalent Lengths† for Cooling Only Systems with Puron® Refrigerant:

The maximum allowable length of a residential split system depends on the liquid line diameter and vertical separation between the indoor and outdoor units. Review “Maximum Total Equivalent Length Outdoor Unit BELOW Indoor Unit,” for the liquid line sizing and maximum lengths.

Maximum Total Equivalent Length Outdoor Unit BELOW Indoor Unit

SIZE	LIQUID LINE CONNECTION (IN. OD)	LIQUID LINE DIAM. W/ TXV (IN. OD)	AC WITH PURON® REFRIGERANT MAXIMUM TOTAL EQUIVALENT LENGTH: OUTDOOR UNIT BELOW INDOOR VERTICAL SEPARATION FT (M)								
			0-5 (0-1.5)	6-10 (1.8-3.0)	11-20 (3.4-6.1)	21-30 (6.4-9.1)	31-40 (9.4-12.2)	41-50 (12.5-15.2)	51-60 (15.5-18.3)	61-70 (18.6-21.3)	71-80 (21.6-24.4)
018 AC with Puron®	3/8	1/4	150	150	125	100	100	75	--	--	--
		5/16	250*	250*	250*	250*	250*	250*	250*	225*	150
		3/8	250*	250*	250*	250*	250*	250*	250*	250*	250*
024 AC with Puron®	3/8	1/4	75	75	75	50	50	--	--	--	--
		5/16	250*	250*	250*	250*	250*	225*	175	125	100
		3/8	250*	250*	250*	250*	250*	250*	250*	250*	250*
030 AC with Puron®	3/8	1/4	30	--	--	--	--	--	--	--	--
		5/16	175	225*	200	175	125	100	75	--	--
		3/8	250*	250*	250*	250*	250*	250*	250*	250*	250*
036 AC with Puron®	3/8	5/16	175	150	150	100	100	100	75	--	--
		3/8	250*	250*	250*	250*	250*	250*	250*	250*	250*
048 AC with Puron®	3/8	3/8	250*	250*	250*	250*	250*	250*	230	160	--
060 AC with Puron®	3/8	3/8	250*	250*	250*	225*	190	150	110	--	--

* Maximum actual length not to exceed 200 ft (61 m)

† Total equivalent length accounts for losses due to elbows or fitting. See the Long Line Guideline for details.

-- = outside acceptable range

Maximum Total Equivalent Length Outdoor Unit ABOVE Indoor Unit

SIZE	LIQUID LINE CONNECTION (IN. OD)	LIQUID LINE DIAM. W/ TXV (IN. OD)	AC WITH PURON® REFRIGERANT MAXIMUM TOTAL EQUIVALENT LENGTH: OUTDOOR UNIT ABOVE INDOOR VERTICAL SEPARATION FT (M)							
			25 (7.6)	26-50 (7.9-15.2)	51-75 (15.5-22.9)	76-100 (23.2-30.5)	101-125 (30.8-38.1)	126-150 (38.4-45.7)	151-175 (46.0-53.3)	176-200 (53.6-61.0)
018 AC with Puron®	3/8	1/4	175	250*	250*	250*	250*	250*	250*	250*
		5/16	250*	250*	250*	250*	250*	250*	250*	250*
		3/8	250*	250*	250*	250*	250*	250*	250*	250*
024 AC with Puron®	3/8	1/4	100	125	175	200	225*	250*	250*	250*
		5/16	250*	250*	250*	250*	250*	250*	250*	250*
		3/8	250*	250*	250*	250*	250*	250*	250*	250*
030 AC with Puron®	3/8	1/4	30	--	--	--	--	--	--	--
		5/16	250*	250*	250*	250*	250*	250*	250*	250*
		3/8	250*	250*	250*	250*	250*	250*	250*	250*
036 AC with Puron®	3/8	5/16	225*	250*	250*	250*	250*	250*	250*	250*
		3/8	250*	250*	250*	250*	250*	250*	250*	250*
048 AC with Puron®	3/8	3/8	250*	250*	250*	250*	250*	250*	250*	250*
060 AC with Puron®	3/8	3/8	250*	250*	250*	250*	250*	250*	250*	250*

* Maximum actual length not to exceed 200 ft (61 m)

† Total equivalent length accounts for losses due to elbows or fitting. See “LONG-LINE APPLICATIONS,” for details.

-- = outside acceptable range

REFRIGERANT CHARGE ADJUSTMENTS

LIQUID LINE SIZE (IN. OD)	PURON CHARGE OZ/FT (G/M)
3/8	0.60 (17.74) (Factory charge for lineset = 9 oz / 266.16 g)
5/16	0.40 (11.83)
1/4	0.27 (7.98)

Units are factory charged for 15 ft (4.6 m) of 3/8" liquid line. The factory charge for 3/8" lineset 9 oz (266.16 g). When using other length or diameter liquid lines, charge adjustments are required per the REFRIGERANT CHARGE ADJUSTMENTS table.

Charging Formula:

$$[(\text{Lineset oz/ft} \times \text{total length}) - (\text{factory charge for lineset})] = \text{charge adjustment}$$

Example 1: System has 15 ft of line set using existing 1/4 "liquid line. What charge adjustment is required?

Formula:

$$(.27 \text{ oz/ft} \times 15\text{ft}) - (9 \text{ oz}) = (4.95) \text{ oz.}$$

Net result is to remove 4.95 oz of refrigerant from the system

Example 2: System has 45 ft of existing 5/16" liquid line. What is the charge adjustment?

Formula:

$$(.40 \text{ oz/ft.} \times 45\text{ft}) - (9 \text{ oz.}) = 9 \text{ oz.}$$

Net result is to add 9 oz of refrigerant to the system

LONG-LINE APPLICATIONS

An application is considered Long-Line, when the refrigerant level in the system requires the use of accessories to maintain acceptable refrigerant management for systems reliability. See ACCESSORY USAGE GUIDELINES on page 7 for the required accessories. Defining a system as long-line depends on the liquid line diameter, actual length of the tubing, and vertical separation between the indoor and outdoor units.

For air conditioner systems, the "AC WITH PURON REFRIGERANT LONG-LINE DESCRIPTION ft (m)" table shows when an application is considered long-line.

AC WITH PURON REFRIGERANT LONG-LINE DESCRIPTION ft (m)

Beyond these lengths, long line accessories are required

LIQUID LINE SIZE (IN. OD)	UNITS ON SAME LEVEL - FT (M)	OUTDOOR BELOW INDOOR - FT (M)	OUTDOOR ABOVE INDOOR - FT (M)
1/4	No accessories needed within allowed lengths	No accessories needed within allowed lengths	175 (53.3)
5/16	120 (36.6)	50 (15.2) vertical or 120 (36.6) total	120 (36.6)
3/8	80 (24.4)	35 (10.7) vertical or 80 24.4) total	80 (24.4)

VAPOR LINE SIZING AND COOLING CAPACITY LOSS

LONG LINE APPLICATION: An application is considered “**long-line**” when the total equivalent tubing length exceeds 80 ft. (24.4 m) or when there is more than 20 ft. (6.09 m) vertical separation between the indoor and outdoor units. These applications require additional accessories and system modifications for reliable system operation. The maximum allowable total equivalent length is up to 250 ft. (76.2 m).

The maximum vertical separation is 200 ft. (60.96 m) when the outdoor unit is above the indoor unit, and up to 80 ft. (24.4 m) when the outdoor unit is below the indoor unit. Refer to the ACCESSORY USAGE GUIDELINES on page 7 for required accessories. See the Long-line Application Guideline for required piping and system modifications. Also, refer to the “Vapor Line Sizing and Cooling Capacity Losses — Puron Refrigerant 1-Stage Air Conditioner Applications” table for the vapor tube diameters based on the total length to minimize the cooling capacity loss.

Vapor Line Sizing and Cooling Capacity Losses — Puron Refrigerant 1-Stage Air Conditioner Applications

UNIT NOMINAL SIZE (BTUH)	MAXIMUM LIQUID LINE DIAMETERS (IN. OD)	VAPOR LINE DIAMETERS (IN. OD)	COOLING CAPACITY LOSS (%) TOTAL EQUIVALENT LINE LENGTH FT. (M)								
			26-50 (7.9-15.2)	51-80 (15.5-24.4)	81-100 (24.7-30.5)	101-125 (30.8-38.1)	126-150 (38.4-45.7)	151-175 (46.0-53.3)	176-200 (53.6-61.0)	201-225 (61.3-68.6)	226-250 (68.9-76.2)
018 1 Stage AC with Puron	3/8	1/2	1	2	3	5	6	7	8	9	11
		5/8	0	1	1	1	2	2	2	3	3
		3/4	0	0	0	0	1	1	1	1	1
024 1 Stage AC with Puron	3/8	5/8	0	1	2	2	3	3	4	5	5
		3/4	0	0	1	1	1	1	1	2	2
		7/8	0	0	0	0	0	1	1	1	1
030 1 Stage AC with Puron	3/8	5/8	1	2	3	3	4	5	6	7	8
		3/4	0	0	1	1	1	2	2	2	3
		7/8	0	0	0	0	1	1	1	1	1
036 1 Stage AC with Puron	3/8	5/8	1	2	4	5	6	8	9	10	12
		3/4	0	1	1	2	2	3	3	4	4
		7/8	0	0	0	1	1	1	1	2	2
048 1 Stage AC with Puron	3/8	3/4	0	1	2	3	4	5	5	6	7
		7/8	0	0	1	1	2	2	2	3	3
		1 1/8	0	0	0	0	0	0	0	1	1
060 1 Stage AC with Puron	3/8	3/4	1	2	4	5	6	7	9	10	11
		7/8	0	1	2	2	3	4	4	5	5
		1 1/8	0	0	0	1	1	1	1	1	1

*Applications in this area may be long-line and may have height restrictions. See LONG-LINE APPLICATIONS on page 4.

ELECTRICAL DATA

UNIT SIZE - VOLTAGE, SERIES	V/PH	OPER VOLTS*		COMPR		FAN	MCA	MAX FUSE** OR CKT BRK AMPS
		MAX	MIN	LRA	RLA	FLA		
18-30	208/230/1	253	197	56.3	9.0	0.50	11.8	20
24-30				62.9	10.9	0.50	14.1	25
30-30				73.0	14.1	0.70	18.3	30
36-30				77.0	14.1	1.20	18.8	30
48-30				124.0	18.5	1.20	24.3	40
60-30				152.5	23.7	1.45	31.1	50
36-50	208/230/3	253	197	71.0	9.0	1.20	12.5	20
48-50				83.1	13.7	1.20	18.3	30
60-50				110.0	15.9	1.45	21.4	35
36-60	460/3	506	414	38.0	5.6	0.60	7.6	15
48-60				41.0	6.2	0.60	8.4	15
60-60				52.0	7.1	0.80	9.7	15

LEGEND:

FLA - Full Load Amps

HACR - Heating, Air Conditioning, Refrigeration

LRA - Locked Rotor Amps

NEC - National Electrical Code

RLA - Rated Load Amps (compressor)

* Permissible limits of the voltage range at which the unit operates satisfactorily

** Time-Delay fuse.

Complies with 2007 requirements of ASHRAE Standards 90.1

A-WEIGHTED SOUND POWER (dBA)

UNIT SIZE	STANDARD RATING (DBA)	TYPICAL OCTAVE BAND SPECTRUM (DBA, WITHOUT TONE ADJUSTMENT)							
		125	250	500	1000	2000	4000	8000	
18	69	50.5	57.0	59.5	64.5	60.5	53.5	43.0	
24	66	50.5	58.5	60.5	59.5	56.5	51.0	41.5	
30	68	55.5	59.5	61.5	63.5	60.0	58.0	49.5	
36	71	59.5	59.5	62.0	65.5	63.5	62.0	55.0	
48	70	57.5	59.5	64.0	66.0	63.0	60.5	54.5	
60	73	60.0	61.5	64.5	67.0	66.0	65.5	58.0	

NOTE: Tested in accordance with AHRI Standard 270-08 (not listed in AHRI).

A-WEIGHTED SOUND POWER (dBA) WITH ACCESSORY SOUND SHIELD

UNIT SIZE	STANDARD RATING (DBA)	TYPICAL OCTAVE BAND SPECTRUM (DBA, WITHOUT TONE ADJUSTMENT)							
		125	250	500	1000	2000	4000	8000	
18	68	52.5	58.0	58.5	64.5	59.5	52.5	42.5	
24	65	54.5	57.5	59.5	59.0	56.0	50.5	40.5	
30	68	55.0	60.0	61.5	62.5	60.0	58.0	49.5	
36	71	59.5	59.5	62.5	65.0	63.0	61.5	55.0	
48	70	57.5	59.5	63.0	65.0	62.5	60.0	54.0	
60	73	61.0	62.0	64.0	67.0	65.5	65.5	57.5	

NOTE: Tested in accordance with AHRI Standard 270-08 (not listed in AHRI).

SOUND PRESSURE LEVELS, (dBA)

UNIT SIZE	AT DISTANCE 10' FROM UNIT	AT DISTANCE 15' FROM UNIT	AT DISTANCE 20' FROM UNIT
18	51.5	48.0	45.5
24	48.5	45.0	42.5
30	50.5	47.0	44.5
36	53.5	50.0	47.5
48	52.5	49.0	46.5
60	55.5	52.0	49.5

NOTE: Sound pressure data vs distance converted using AHRI 275 Standard under certain environmental and layout assumptions.

CHARGING SUB-COOLING (TXV-TYPE EXPANSION DEVICE)

UNIT SIZE-SERIES	REQUIRED SUBCOOLING °F (°C)
18	12 (6.7)
24	12 (6.7)
30	12 (6.7)
36	8 (4.4)
48	12 (6.7)
60	10 (5.6)

NOTE: The conversion is accurate **only** when all the assumptions are correct.

DIMENSIONS-ENGLISH

UNIT	Series	Electrical Characteristics				A	B	C	D	E	F	G	H	J	K	L	M	N	P	Operating Weight (lbs)	Shipping Weight (lbs)	Shipping Dimensions (L x W x H)	
24AHA418	0	X	0	0	0	31 1/8"	36 15/16"	14 9/16"	16"	23 7/16"	17 3/16"	23 1/8"	28 1/16"	13"	6 5/8"	11 1/4"	5/8"	2 7/8"	5 13/16"	146	166	42 15/16" x 18" x 34 1/8"	
24AHA424	0	X	0	0	0	31 1/8"	36 15/16"	14 9/16"	16"	23 7/16"	17 3/16"	23 1/8"	28 1/16"	14"	6 3/4"	11 5/8"	3/4"	2 7/8"	5 13/16"	148	168	42 15/16" x 18" x 34 1/8"	
24AHA430	0	X	0	0	0	37 1/8"	44 1/2"	17 1/16"	18 7/16"	30 1/2"	19 5/8"	29 1/8"	34 1/16"	13 11/16"	8 1/8"	15 7/8"	3/4"	3 3/8"	6 3/8"	183	213	50 1/2" x 20 1/2" x 40 1/8"	
24AHA436	0	X	0	X	X	37 1/8"	44 1/2"	17 1/16"	18 7/16"	30 1/2"	19 5/8"	29 1/8"	34 1/16"	13 11/16"	8 1/8"	15 7/8"	7/8"	3 3/8"	6 3/8"	184	214	50 1/2" x 20 1/2" x 40 1/8"	
24AHA448	0	X	0	X	X	37 1/8"	44 1/2"	17 1/16"	18 7/16"	30 1/2"	19 5/8"	29 1/8"	34 1/16"	14 1/2"	8 1/2"	18 7/8"	7/8"	3 3/8"	6 3/8"	213	243	50 1/2" x 20 1/2" x 40 1/8"	
24AHA460	0	X	0	X	X	43 1/8"	44 1/2"	17 1/16"	18 7/16"	30 1/2"	19 5/8"	35 1/8"	40 1/16"	14 1/2"	8 1/2"	18 7/8"	7/8"	3 3/8"	6 3/8"	245	275	50 1/2" x 20 1/2" x 46 1/8"	
		208-230-1-60																					
		203-1-60																					
		208/230-3-60																					
		460-3-60																					

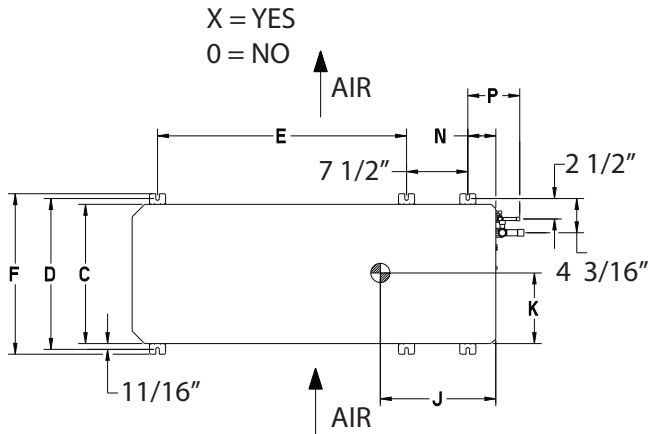

Fig. 2 — Dimensions

1. Clearance Requirements:

a. Single Unit Applications:

With the coil facing the wall, allow 6in (152mm) minimum clearance on the coil side, the coil end, and allow 20in (508mm) minimum clearance on the fan side.

With the fan facing the wall, allow 8in (203mm) minimum clearance on the fan side, 6in (152mm) on the coil end and 20in (508mm) minimum clearance on the coil side.

b. Multi Unit Applications:

Allow 24in (610mm) minimum clearance between the fan and the coil sides of the multiple units. Arrange the units so the discharge of one unit does not enter the inlet of the other unit. When two units are installed end to end with the coil ends facing each other allow 12in (305mm) in minimum clearance between the units.

c. Compressor End Service Clearance:

Allow 24in (610mm) minimum clearance on the compressor end when the units are stacked or there is less than 40 in. (1016mm) of clearance above the top of the unit. If there is 40 in. (1016mm) of clearance above the unit and top panel is accessible for removal, allow 8in (203mm) minimum clearance minimum clearance on the compressor end for service.

IMPORTANT: When installing single or multiple units in an alcove, roof well, or partially enclosed area, ensure there is adequate ventilation to prevent recirculation of discharged air.

- Minimum outdoor operating ambient in the **COOLING** mode is 55°F (13°C) and a maximum of 125°F (52°C).
- Series designation is the 13th position of the unit model number
- Center of gravity
- All dimensions are in inches unless noted.

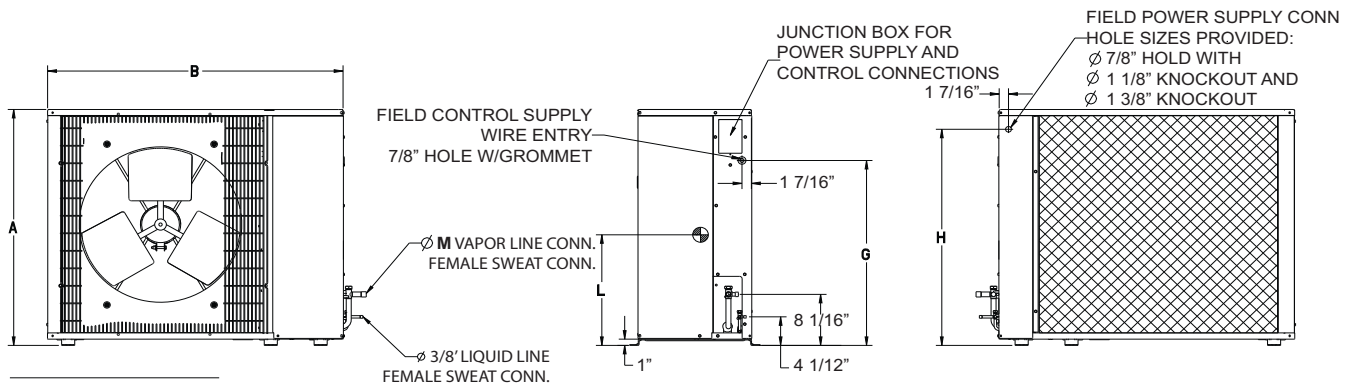

Fig. 3 — Dimensions

UNIT SIZE	MINIMUM MOUNTING PAD DIMENSIONS
18,24	23" x 42"
30,36,48,60	24" x 50"

CONDENSER ONLY RATINGS

SST °F (°C)		CONDENSER ENTERING AIR TEMPERATURES °F (°C)							
		55 °F (12.78°C)	65 °F (18.33°C)	75 °F (23.89°C)	85 °F (29.44°C)	95 °F (35.0°C)	105 °F (40.56°C)	115 °F (46.11°C)	125 °F (51.67°C)
24AHA418A30									
30°F (-1.11°C)	TCG	16.60	15.60	14.70	13.80	12.90	12.00	11.10	10.10
	SDT	68.50	78.00	87.50	97.00	106.50	116.00	125.40	134.70
	KW	0.76	0.87	0.99	1.11	1.25	1.40	1.59	1.80
35°F (1.67°C)	TCG	18.30	17.20	16.30	15.30	14.30	13.30	12.30	11.20
	SDT	69.70	79.20	88.70	98.20	107.60	117.00	126.30	135.50
	KW	0.76	0.87	0.99	1.11	1.25	1.41	1.59	1.80
40°F (4.44°C)	TCG	20.00	19.00	17.90	16.90	15.80	14.70	13.60	12.40
	SDT	71.10	80.50	89.90	99.40	108.70	118.00	127.20	136.30
	KW	0.77	0.88	0.99	1.11	1.25	1.41	1.59	1.80
45°F (7.22°C)	TCG	22.00	20.80	19.70	18.50	17.40	16.20	14.90	13.60
	SDT	72.50	81.90	91.30	100.60	109.80	119.00	128.20	137.20
	KW	0.77	0.88	0.99	1.12	1.26	1.41	1.59	1.80
50°F (10.0°C)	TCG	24.00	22.80	21.60	20.40	19.10	17.80	16.40	15.00
	SDT	74.00	83.40	92.60	101.90	111.00	120.10	129.20	138.20
	KW	0.77	0.88	0.99	1.12	1.26	1.41	1.59	1.80
55°F (12.78°C)	TCG	26.30	25.00	23.60	22.30	20.90	19.50	18.00	16.40
	SDT	75.60	84.80	94.10	103.20	112.30	121.30	130.30	139.20
	KW	0.78	0.88	1.00	1.12	1.26	1.42	1.60	1.80
24AHA424A30									
30°F (-1.11°C)	TCG	21.40	20.20	19.00	17.80	16.60	15.40	14.20	12.90
	SDT	71.90	81.30	90.70	100.00	109.30	118.50	127.70	136.80
	KW	1.01	1.15	1.30	1.46	1.64	1.85	2.09	2.36
35°F (1.67°C)	TCG	23.50	22.20	20.90	19.60	18.30	17.00	15.60	14.20
	SDT	73.50	82.80	92.10	101.30	110.50	119.60	128.70	137.70
	KW	1.02	1.16	1.30	1.47	1.65	1.86	2.09	2.37
40°F (4.44°C)	TCG	25.70	24.40	23.00	21.60	20.20	18.70	17.20	15.60
	SDT	75.10	84.30	93.50	102.60	111.80	120.80	129.80	138.80
	KW	1.02	1.16	1.31	1.47	1.66	1.86	2.10	2.38
45°F (7.22°C)	TCG	28.20	26.70	25.20	23.70	22.10	20.50	18.90	17.10
	SDT	76.70	85.90	95.00	104.10	113.10	122.10	131.00	139.80
	KW	1.03	1.17	1.32	1.48	1.66	1.87	2.11	2.39
50°F (10.0°C)	TCG	30.80	29.20	27.50	25.90	24.20	22.40	20.60	18.70
	SDT	78.50	87.50	96.60	105.60	114.60	123.40	132.20	140.90
	KW	1.04	1.18	1.32	1.49	1.67	1.88	2.12	2.39
55°F (12.78°C)	TCG	33.60	31.80	30.10	28.30	26.40	24.50	22.40	20.30
	SDT	80.30	89.30	98.30	107.20	116.10	124.90	133.50	142.00
	KW	1.05	1.18	1.33	1.50	1.68	1.89	2.13	2.40
24AHA430A30									
30°F (-1.11°C)	TCG	27.20	25.80	24.40	22.90	21.40	19.70	17.90	16.00
	SDT	69.90	79.20	88.60	98.00	107.30	116.60	125.80	134.80
	KW	1.22	1.39	1.57	1.77	2.00	2.27	2.58	2.94
35°F (1.67°C)	TCG	30.10	28.50	27.00	25.40	23.70	21.90	20.00	17.90
	SDT	71.20	80.60	89.90	99.20	108.50	117.70	126.80	135.80
	KW	1.22	1.40	1.58	1.78	2.01	2.28	2.58	2.94
40°F (4.44°C)	TCG	33.10	31.40	29.70	28.00	26.20	24.30	22.20	20.00
	SDT	72.70	82.00	91.20	100.50	109.70	118.90	127.90	136.90
	KW	1.23	1.41	1.59	1.80	2.03	2.29	2.59	2.94
45°F (7.22°C)	TCG	36.50	34.50	32.70	30.80	28.80	26.80	24.50	22.10
	SDT	74.30	83.50	92.70	101.90	111.00	120.10	129.10	137.90
	KW	1.25	1.43	1.61	1.82	2.05	2.31	2.60	2.95
50°F (10.0°C)	TCG	40.00	37.90	35.80	33.80	31.60	29.40	27.00	24.40
	SDT	76.00	85.10	94.20	103.40	112.40	121.40	130.30	139.00
	KW	1.27	1.45	1.64	1.84	2.07	2.33	2.62	2.95
55°F (12.78°C)	TCG	43.80	41.40	39.20	36.90	34.60	32.10	29.50	26.70
	SDT	77.90	86.90	95.90	104.90	113.90	122.80	131.50	140.20
	KW	1.29	1.47	1.66	1.87	2.09	2.35	2.64	2.97

See notes on page 15.

GENERAL

24AHA4

SYSTEM DESCRIPTION

1-1/2 TO 5 NOMINAL TONS

Outdoor-mounted, air-cooled, split-system air conditioning unit suitable for ground or rooftop installation. Unit consists of a scroll-type hermetic compressor, an air-cooled coil, propeller-type condenser fan, and a control box. Unit discharges supply air horizontally as shown on contract drawings.

Unit should be used in a refrigeration circuit to match up to a packaged fan coil or furnace.

Quality Assurance

- Unit is rated in accordance with the latest edition of AHRI Standard 210.
- Unit is certified for capacity and efficiency, and listed in the latest AHRI directory.
- Unit construction complies with latest edition of ANSI/ASHRAE and with NEC.
- Unit is constructed in accordance with UL standards and carries the UL label of approval. Unit has c-UL approval.
- Unit cabinet is capable of withstanding Federal Test Method Standard No. 141 (Method 6061) 500-hr salt spray test.
- Air-cooled condenser coils are leak tested and pressure tested
- Unit is constructed in a ISO9001 approved facility.

Delivery, Storage, and Handling

- Unit is shipped as single package only and is stored and handled per unit manufacturer's recommendations.
- Warranty (for inclusion by specifying engineer)
- U.S. and Canada only.

PRODUCTS

Equipment

- Factory assembled, single piece, air-cooled air conditioning unit. Contained within the unit enclosure is all factory wiring, piping, controls, compressor, refrigerant charge Puron® (R-410A), and special features required prior to field start-up.

Unit Cabinet

- Unit cabinet is constructed of galvanized steel and bonderized.

Fans

- Condenser fan is direct-drive propeller type, discharging air horizontally

- Condenser fan motors are totally enclosed, 1-phase type with class B insulation and permanently lubricated bearings. Shafts are corrosion resistant.
- Fan blades are statically and dynamically balanced.
- Condenser fan openings are equipped with coated steel wire safety guards

Compressor

- Compressor is a scroll-type, hermetically sealed.
- Compressor is mounted on rubber vibration isolators.

Condenser Coil

- Condenser coil is air cooled.
- Coil is constructed of aluminum fins mechanically bonded to copper tubes which are then cleaned, dehydrated, and sealed.

Refrigeration Components

- Refrigeration circuit components include liquid-line front-seating shutoff valve with sweat connections, vapor-line front-seating shutoff valve with sweat connections, system charge of Puron® (R-410A) refrigerant, and compressor oil.
- Unit is equipped with high-pressure switch and filter drier for Puron® refrigerant.

Operating Characteristics

- The capacity of the unit meets or exceeds _____ Btuh at a suction temperature of _____ °F/°C. The power consumption at full load does not exceed _____ kW.
- Combination of the unit and the evaporator or fan coil unit has a total net cooling capacity of _____ Btuh or greater at conditions of _____ CFM entering air temperature at the evaporator at _____ °F/°C wet bulb and _____ F/C dry bulb, and air entering the unit at _____ F/C.
- The system has a SEER of _____ Btuh/watt or greater at DOE conditions.

Electrical Requirements

- Nominal unit electrical characteristics is _____ v, single phase, 60 hz. The unit is capable of satisfactory operation within voltage limits of _____ v to _____ v.
- Nominal unit electrical characteristics is _____ v, three phase, 60 hz. The unit is capable of satisfactory operation within voltage limits of _____ v to _____ v.
- Unit electrical power is a single point connection.
- Control circuit is 24V.

Special Features

- Refer to the section of this literature identifying accessories and descriptions for specific features and available enhancements.

FV4C
Performance™ Series Fan Coil
Sizes 002 Thru 006



Product Data



PREMIUM ENVIRONMENTALLY RESPONSIBLE FAN COIL

The FV4C is the premium air handler combining the proven technology of Carrier fan coils with environmentally balanced Puron® refrigerant. The FV4C achieves an operational advantage when the ECM (Electronically Commutated Motor) is combined with a Carrier Performance™ heat pump with Puron® refrigerant.

With attention to quiet, efficient, and comfortable operation, Carrier has developed a new benchmark for superior indoor comfort and control.

Carrier's heat pump and air conditioning systems now feature Puron® refrigerant (R-410A), the chlorine-free refrigerant that is the future for the residential heating and cooling industry. The FV4C using Puron® refrigerant maximizes performance for environmentally balanced systems. In addition to environmental safety, these systems are 30 to 40% more efficient than standard heating and cooling systems, thereby combining excellence in efficiency and environmental responsibility.

The FV4C provides these benefits due to Carrier's command of ECM technology. These motors are extremely efficient at all speeds, and enable the FV4C to operate at the correct speed to deliver airflow precisely, ensuring proper performance across a wide range of duct static pressures. This adaptive efficiency also makes installation quality easier to achieve for today's demanding homeowner.

Carrier's command of ECM technology may be most evident in the comfort advantages that ECM can deliver. Operation set up steps on the Easy Select™ Board provide the installing technician with alternatives to maximize comfort and efficiency. For true indoor comfort, the homeowner can achieve command of both temperature and humidity in cooling and heating modes.

Another feature which sets the FV4C apart is the factory-installed TXV, which enhances efficiency and provides compressor protecting operation at all recommended conditions. Grooved tubing, louvered aluminum fins, and the large face areas of the FV4C refrigerant coils also provide superior efficiency, for high SEER and HSPF performance. Carrier leads the way in condensate control, a hallmark of these multipoise fan coils. All of these featured components are protected within a rugged, prepainted metal cabinet lined with super thick, high density insulation. For neat, high quality installations the unit exterior features sweat refrigerant connections for simple leak free performance, and multiple electrical entry for both high and low voltage service.

Assembled at the factory compliant with low leak requirements of less than 2% cabinet leakage rate at 0.5 inches W.C. and 1.4% cabinet leakage rate at 0.5 inches W.C. when tested in accordance with ASHRAE 193 standard.

FEATURES

Environmentally Balanced Refrigerant Technology

- Puron®, chlorine-free, non-ozone depleting refrigerant
- Thermostatic Expansion Valve (TXV) designed to maximize performance with Puron® refrigerant

Energy Efficient Operation

- Electronically Commutating Motor (ECM) operates efficiently at all speeds
- Maximizes efficiency of heating and cooling systems
- Ultra low power consumption during fan only operation

Indoor Weather Control

- Warm, comfortable heating air temperatures
- Unmatched humidity control, especially with Carrier's thermostat with relative humidity controls

Airflow and Sound Technology

- Diffuser air discharge section for high airflow efficiency and quiet, smooth operation
- High duct static capability
- Design meets stringent regulations for cabinet air leakage of less than 2% when tested at 0.5 inches W.C., and cabinet air leakage less than 1.4% at 0.5 inches W.C. when tested in accordance with ASHRAE 193 standard.

Condensate Control and Disposal Technology

- Minimal standing waterless microbial growth for improved IAQ and reduced condensate line clogging and related condensate leakage
- Condensate fittings relocated away from turbulent airflow patterns at the blower entrance for improved condensate control performance
- Overflow feature for slope coil units allows condensate to exit the unit without damage to product under clogged primary and secondary line conditions
- Tested for condensate disposal at conditions much more severe than those required by AHRI
- Primary and secondary drain connections to comply with HUD
- All pans constructed of an injection molded glass-filled polycarbonate engineered resin material, with brass drain connections.
- High density, super thick cabinetry insulation with vapor barrier
- Pre-painted galvanized sheet metal cabinet

Heat Transfer Technology

- Grooved tubing
- Lanced sine wave aluminum fins
- Discreet refined counter-flow refrigerant circuitry
- Bi-flow hard shut-off TXV metering device

Quality Assisting, Ease of Installation and Service Features

- All units multipoise
- Provision made for suspending from roof or ceiling joints
- Modular cabinet on 003 thru 006 units
- Sweat connections for leak free service
- Multiple electrical entry for application flexibility (high and low voltage)
- Low voltage terminal strip, to safely hold connections within the cabinet
- Cabinet construction features innovations designed to prevent cabinet sweating

Controls and Electrical Features

- Easy Select™ Board to maximize comfort, efficiency, and safe heater airflow operation
- Easy plug connection provided for quick installation of accessory heater packages
- 40VA 208/230v transformer
- Replaceable 5-amp blade-type auto fuse protects against transformer secondary short

Filter Features

- Factory supplied filter
- Cleanable polyester filter media
- Filter "springs" out for easy access – no tools required
- Newly improved filter rack area – filter door insulation added for an improved air seal

MODEL NUMBER NOMENCLATURE

1 2 3 4 5 6 7 8 9 10 11 12
 F V 4 C N B 0 0 3 0 0 0

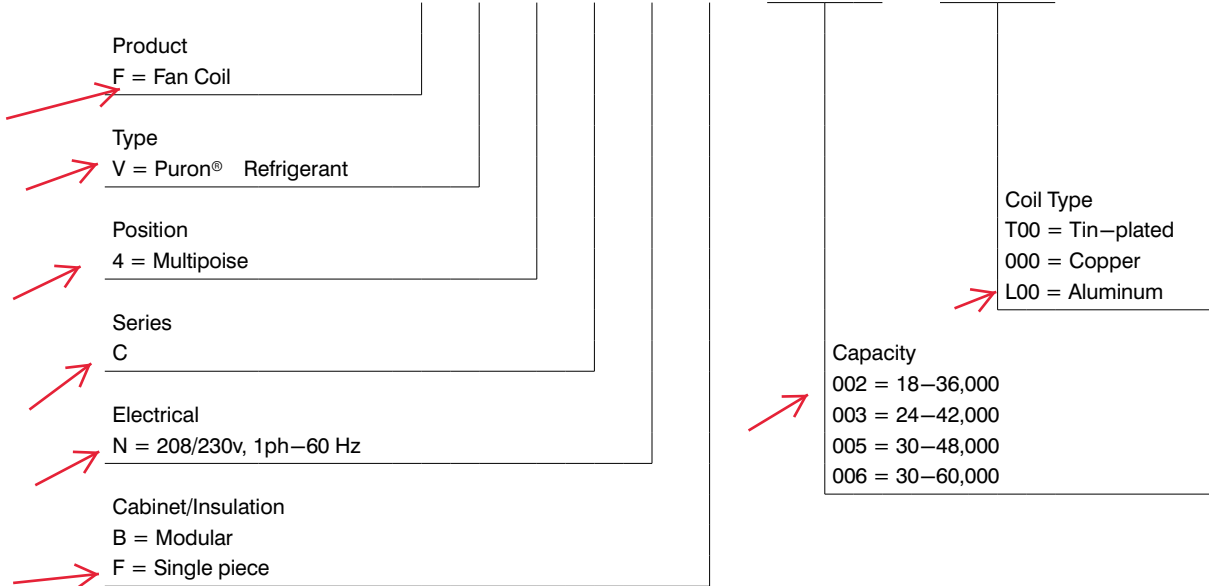

Use of the AHRI Certified TM Mark indicates a manufacturer's participation in the program. For verification of certification for individual products, go to www.ahridirectory.org.



ISO 9001
OMI-SAI Global



SPECIFICATIONS

MODEL FV4C	002	003	005	006
COIL				
Refrigerant Metering Device	Puron® Refrigerant (R-410A)			
TXV Size	2 Ton	3 Ton	4 Ton	5 Ton
Rows/Fins Per In.	3 / 14.5			
Face Area (Sq Ft)	3.46		5.93	7.42
Configuration	A	Slope	A	
BLOWER & MOTOR				
Air Discharge	Upflow, Downflow, Horizontal			
CFM (Nominal Clg/Htg)	525 / 470	700 / 630	875 / 785	1050 / 945
	700 / 630	875 / 785	1050 / 945	1225 / 1100
	875 / 785	1050 / 945	1225 / 1100	1400 / 1260
	1050 / 945	1225 / 1100	1400 / 1260	1750 / 1575
Motor HP (ECM)	1/2			3/4
FILTER CLEANABLE				
21-1/2" (546 mm) by	16-3/8" (417 mm)	19-7/8" (505 mm)		23-5/16" (585 mm)
CABINET CONFIGURATION OPTIONS				
	1 Piece	1 Piece or Modular		Modular

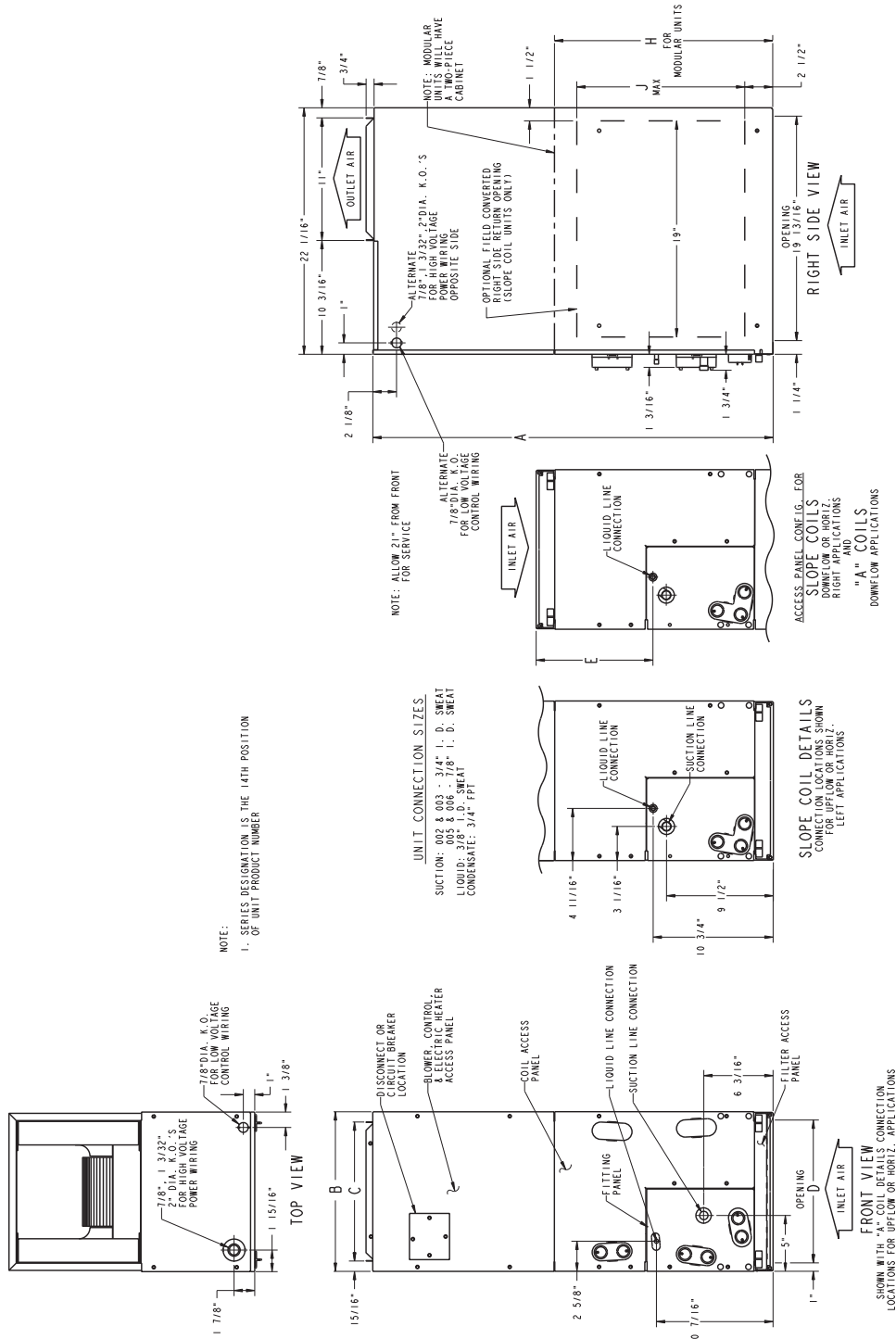

DIMENSIONS

UNIT SIZE	A		B		C		D		E		H		J	
	in	mm	in	mm	in	mm	in	mm	in	mm	in	mm	in	mm
FV4CNB003	53-7/16	1357	21-1/8	537	19-1/4	489	19-1/8	486	19-3/16	487	28-5/16	735	19	483
FV4CNB005	53-7/16	1357	21-1/8	537	19-1/4	489	19-1/8	486	19-3/16	487	28-5/16	735	—	—
FV4CNB006	59-3/16	1503	24-11/16	627	22-3/4	578	22-11/16	576	25-1/4	642	34-1/16	865	—	—
FV4CNF002	42-11/16	1084	17-5/8	448	15-3/4	400	15-5/8	397	10-3/4	273	—	—	—	—
FV4CNF003	53-7/16	1357	21-1/8	537	19-1/4	489	19-1/8	486	19-3/16	487	—	—	19	483
FV4CNF005	53-7/16	1357	21-1/8	537	19-1/4	489	19-1/8	486	19-1/2	495	—	—	—	—



SLOPE COIL

NOTES:
1. CONDENSATE PAN DRAIN CAPS NOT SHOWN FOR CLARITY.

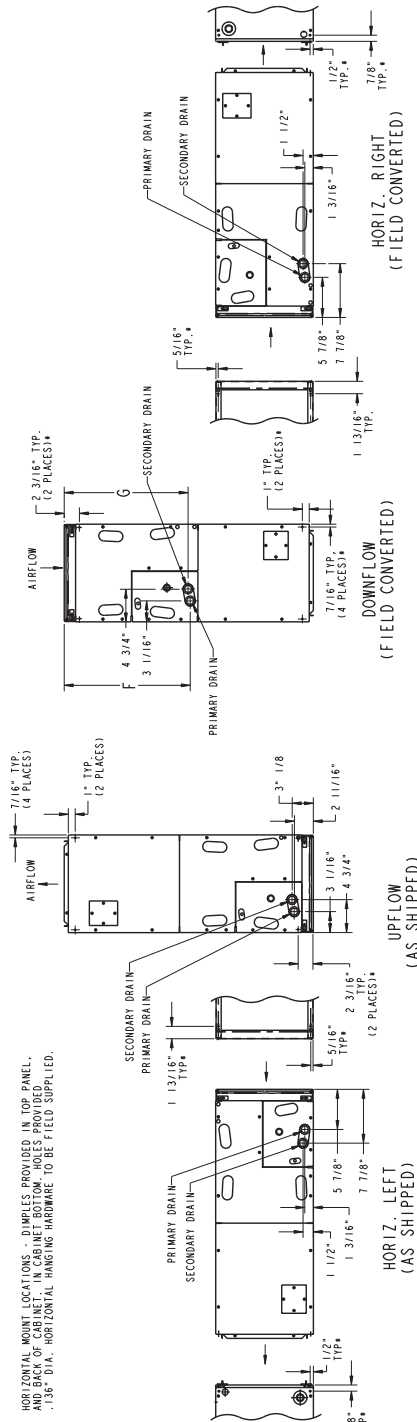
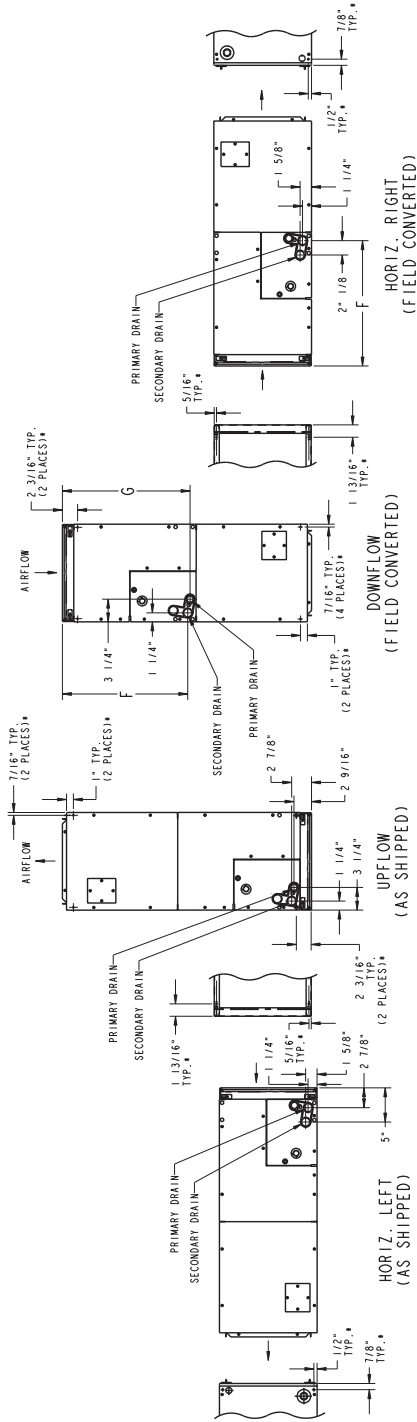

* HORIZONTAL MOUNT LOCATIONS - DIMPLES PROVIDED IN TOP PANEL, AIRFLOW TO BE SUPPLIED FROM TOP. HORIZONTAL HANGING HARDWARE TO BE FIELD SUPPLIED.

A-COIL

DIMENSIONS

UNIT SIZE	F		G		COIL TYPE		SHIPPING WEIGHT	
	in	mm	in	mm			lb	kg
FV4CNB003	26-15/16	684	27-1/2	699	SLOPE		150	68
FV4CNB005	26-15/16	684	27-1/2	699	A		172	78
FV4CNB006	32-15/16	837	32-5/8	829	A		207	94
FV4CNF002	18-9/16	471	18-1/4	464	A		135	61
FV4CNF003	26-15/16	684	27-1/2	699	SLOPE		150	68
FV4CNF005	27-1/4	692	26-15/16	684	A		172	78



PERFORMANCE DATA

FV4C ADVANCED FAN COIL AIRFLOW DELIVERY CHART (CFM)

OPERATING MODE										
UNIT SIZE	OUTDOOR UNIT CAPACITY	SINGLE—SPEED APPLICATION		TWO—SPEED APPLICATION				FAN ONLY		
		Nominal A/C Cooling	A/C Cooling Dehumidity	High Speed		Low Speed		Lo	Med	High
				Nominal A/C Cooling	A/C Cooling Dehumidity	Nominal A/C Cooling	A/C Cooling Dehumidity			
002	018	525	420	—	—	—	—	350	420	525
	024	700	560	700	560	560	450	350	560	700
	030	875	700	—	—	—	—	440	700	875
	036	1050	840	1050	840	840	670	525	840	1050
003	024	700	560	700	560	560	450	415	560	700
	030	875	700	—	—	—	—	440	700	875
	036	1050	840	1050	840	840	670	525	840	1050
	042	1225	980	—	—	—	—	610	980	1225
005	030	875	700	—	—	—	—	440	700	875
	036	1050	840	1050	840	840	670	525	840	1050
	042	1225	980	—	—	—	—	610	980	1225
	048	1400	1120	1400	1120	1120	895	700	1120	1400
006	036	1050	840	1050	840	840	670	540	840	1050
	042	1225	980	—	—	—	—	610	980	1225
	048	1400	1120	1400	1120	1120	895	700	1120	1400
	060	1750	1400	1750	1400	1400	1120	875	1400	1750

NOTES:

1. The above airflows result with the AC, HP CFM ADJUST select jumper set on NOM.
2. Air flow can be adjusted +15% or -10% by selecting HI or LO respectively for all modes except fan only.
3. Dry coil at 230 volts and with 10kW heater and filter installed.
4. Airflows shown are at standard air conditions.

*Consult ARI ratings before matching outdoor unit with FV4C fan coil.

FV4C ADVANCED FAN COIL AIRFLOW DELIVERY CHART (CFM)

OPERATING MODE										
UNIT SIZE	OUTDOOR UNIT CAPACITY	SINGLE—SPEED APPLICATION		TWO—SPEED APPLICATION				FAN ONLY		
		Heat Pump Comfort	Heat Pump Efficiency	High Speed		Low Speed		Lo	Med	High
				Heat Pump Comfort	Heat Pump Efficiency	Heat Pump Comfort	Heat Pump Efficiency			
002	018	470	525	—	—	—	—	350	380	470
	024	630	700	630	700	505	560	350	505	630
	030	785	875	—	—	—	—	390	630	785
	036	945	1050	945	1050	755	840	470	755	945
003	024	630	700	630	700	415	560	415	505	630
	030	785	875	—	—	—	—	415	630	785
	036	945	1050	945	1050	755	840	470	755	945
	042	1100	1225	—	—	—	—	550	880	1100
005	030	785	875	—	—	—	—	425	630	785
	036	945	1050	945	1050	755	840	470	755	945
	042	1100	1225	—	—	—	—	550	880	1100
	048	1260	1400	1260	1400	1010	1120	630	1010	1260
006	036	945	1050	945	1050	755	840	540	755	945
	042	1100	1225	—	—	—	—	550	880	1100
	048	1260	1400	1260	1400	1010	1120	630	1010	1260
	060	1575	1750	1575	1750	1260	1400	785	1260	1575

NOTES:

1. The above airflows result with the AC, HP CFM ADJUST select jumper set on NOM.
2. Air flow can be adjusted +15% or -10% by selecting HI or LO respectively for all modes except fan only.
3. Dry coil at 230 volts and with 10kW heater and filter installed.
4. Airflows shown are at standard air conditions.

PERFORMANCE DATA (cont)

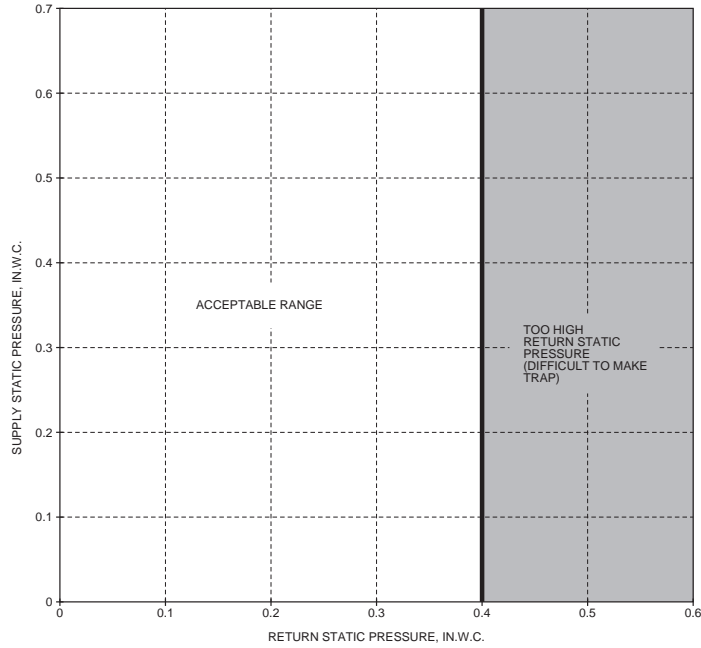

A02296

ACCEPTABLE DUCT CONDITIONS

For satisfactory operation (specifically making dry secondary trap), subject fan coils must be installed with duct systems which fall within the “Acceptable Range” illustrated above.

The airflow performance charts for the FV4C fan coil depict nominal airflow delivery for heating and cooling mode operation versus duct system static pressure drop. Cooling mode operation is shown as solid vertical lines for all 4 system size selections. Heating mode operation for the 4 system size selections are shown as dashed vertical lines.

The dotted curved lines are static pressure drop characteristics for several fixed-duct systems. These lines can be used to predict the

system static pressure drop at any airflow given the actual drop at 1 known point.

For example, a duct system is designed for 0.15 in. water column (in. w.c.) drop at 1200 CFM. The FV4CNF005 operating at nominal cooling airflow would deliver 1050 CFM with a duct system drop of 0.11 in. w.c.. (See point 1.) On the same drop of system, the FV4CNF005 operating at nominal heating airflow would deliver 945 CFM with a duct system drop of 0.09 in. w.c. (See point 2.)

This example is but one of many possible duct system designs. The FV4CNF005 will deliver the above airflows against much higher static pressures.

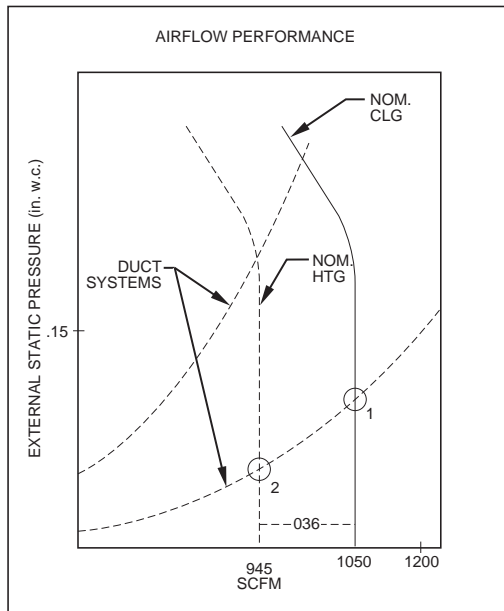

A09339

AIRFLOW PERFORMANCE

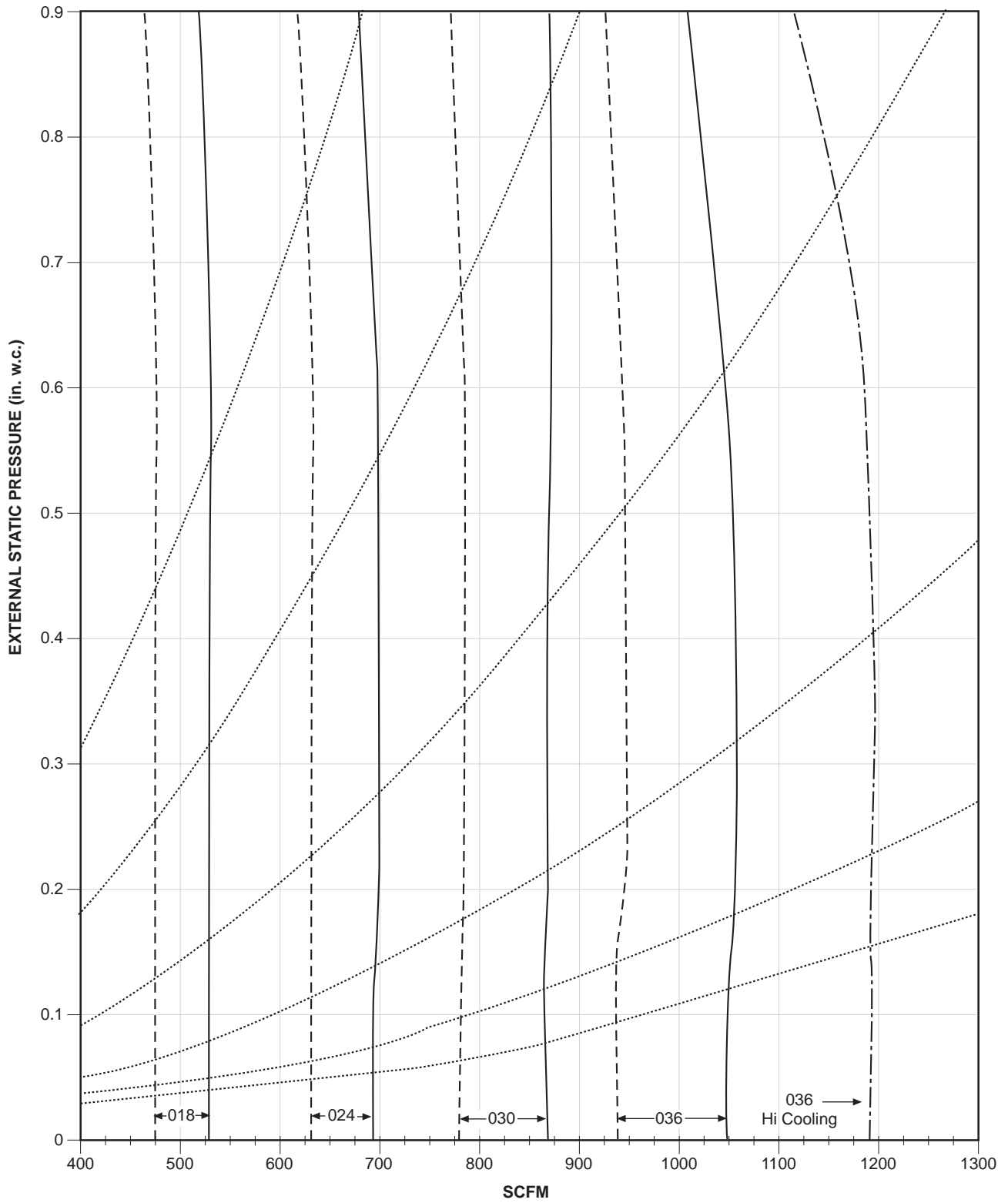

A09340

FV4CNF002

- Nominal Cooling and Heat Pump Efficiency airflow for each size selection. Airflow can be adjusted +15% to -10%.
- - - Nominal Heat Pump Comfort airflow for each size selection. Airflow can be adjusted +15% to -10%.
- · · Maximum cooling airflow for largest size selection. Adjusted +15% from nominal.
- · · Fixed Duct Systems (See description under Acceptable Duct Conditions.)

PERFORMANCE DATA (cont)

COOLING CAPACITIES (MBtuh)

UNIT SIZE	EVAP COIL AIR Cfm BF	SATURATED TEMPERATURE LEAVING EVAPORATOR (°F / °C)														
		35 / 2			40 / 4			45 / 7			50 / 10			55 / 13		
		Evaporator Air — Entering Wet-Bulb Temperature														
		72°F 22°C	67°F 19°C	62°F 17°C	72°F 22°C	67°F 19°C	62°F 17°C	72°F 22°C	67°F 19°C	62°F 17°C	72°F 22°C	67°F 19°C	62°F 17°C	72°F 22°C	67°F 19°C	62°F 17°C
002	500 0.04	40	32	26	36	28	22	32	24	18	27	19	14	21	13	11
		18	18	19	16	16	17	14	14	15	12	12	13	10	10	11
	650 0.07	50	40	32	45	36	27	39	30	22	33	24	18	26	17	14
		21	22	23	19	20	21	16	17	18	14	15	16	12	13	14
	875 0.10	58	49	38	53	42	32	46	35	27	39	28	22	31	20	18
		24	26	28	22	24	25	19	21	22	17	19	19	15	16	18
003	1000 0.11	62	51	41	56	45	35	50	38	29	42	30	24	33	22	20
		26	28	31	23	26	28	21	23	25	18	20	21	16	18	20
	1250 0.13	67	55	45	61	49	39	54	42	33	46	34	28	37	25	24
		29	33	36	27	30	33	24	27	30	22	24	26	19	21	24
	800 0.20	59	48	38	53	42	32	46	35	24	39	27	20	30	18	16
		28	29	31	25	27	28	22	23	24	19	20	20	16	16	16
005	1000 0.22	68	56	45	61	49	37	54	41	29	45	32	25	35	22	20
		32	34	37	29	31	33	26	28	28	23	24	25	19	20	20
	1200 0.25	75	62	49	68	54	42	60	45	34	50	36	29	40	25	23
		35	39	42	32	36	38	29	32	33	26	28	29	22	23	23
	1400 0.27	80	67	54	73	59	46	64	49	38	54	39	32	43	28	27
		38	43	47	35	39	43	32	36	37	28	32	32	24	26	27
006	750 0.04	61	49	39	55	43	33	48	37	27	41	29	20	33	21	17
		27	27	28	24	25	25	21	22	22	18	18	18	15	15	15
	950 0.06	74	60	48	67	53	40	59	45	33	50	35	25	39	24	21
		32	34	35	29	30	31	25	26	27	22	23	23	18	18	19
	1150 0.07	89	72	57	79	63	48	69	52	38	58	41	31	44	29	25
		37	39	41	33	35	36	29	31	32	25	26	27	20	22	22
006	1500 0.10	103	84	66	92	73	56	81	61	46	67	48	39	52	34	31
		43	46	49	38	41	44	34	37	39	29	32	33	25	27	27
	1700 0.11	110	89	71	99	78	60	86	65	49	72	51	42	56	37	35
		45	50	53	41	45	48	36	39	42	31	34	36	27	29	30
	1050 0.01	77	62	50	69	55	43	61	47	35	52	38	27	41	27	22
		34	36	37	31	32	33	27	28	29	23	25	24	20	20	20
006	1300 0.02	100	82	65	90	71	55	79	60	45	66	47	37	49	32	27
		42	45	47	37	40	42	33	35	37	29	31	32	23	25	24
	1750 0.04	117	96	77	106	84	65	93	71	53	78	56	46	60	40	34
		48	53	57	44	48	52	39	43	46	34	38	39	29	31	31
	2050 0.05	126	103	83	114	91	71	99	76	59	84	60	50	65	44	39
		52	58	63	48	53	57	43	47	51	37	42	43	33	35	35
006	2300 0.06	132	108	87	119	95	75	105	80	63	88	63	54	70	47	42
		55	62	68	50	57	61	45	51	54	40	45	46	35	39	38

BF – Bypass Factor

■ – Sensible Heat Capacity (1000 Btuh)

□ – Gross Cooling Capacity (1000 Btuh)

NOTES:

- Contact manufacturer for cooling capacities at conditions other than shown in table.
- Formulas:
 Leaving db = entering db – $\frac{\text{sensible heat cap.}}{1.09 \times \text{CFM}}$
 Leaving wb = wb corresponding to enthalpy of air leaving coil (h_{lwb})
 $h_{lwb} = h_{ewb} - \frac{\text{total capacity (Btuh)}}{4.5 \times \text{CFM}}$
 where h_{ewb} = enthalpy of air entering coil. Direct interpolation is permissible. Do not extrapolate.
- SHC is based on 80°F db temperature of air entering coil. Below 80°F db, subtract (Correction Factor x CFM) from

SHC. Above 80°F db, add (Correction Factor x CFM) to SHC.

- Bypass Factor = 0 indicates no psychometric solution. Use bypass factor of next lower EWB for approximation.

SHC CORRECTION FACTOR

BYPASS FACTOR	ENTERING AIR DRY-BULB TEMPERATURE °F (°C)					
	79 (26)	78 (26)	77 (25)	76 (24)	75 (24)	Under 75 (24)
	81 (27)	82 (28)	83 (28)	84 (29)	85 (29)	Over 85
	Correction Factor					
0.10	.098	1.96	2.94	3.92	4.91	Use formula shown below
0.20	0.87	1.74	2.62	3.49	4.36	
0.30	0.76	1.53	2.29	3.05	3.82	

Interpolation is permissible.

Correction Factor = $1.09 \times (1 - \text{BF}) \times (\text{db} - 80)$

PERFORMANCE DATA (cont)

ESTIMATED SOUND POWER LEVEL (dBA)*

UNIT SIZE	CONDITIONS		OCTAVE BAND CENTER FREQUENCY						
	CFM	ESP	63	125	250	500	1000	2000	4000
FV-002	400	0.25	63.0	59.0	55.0	52.0	50.0	48.0	44.0
	600	0.25	64.7	60.7	56.7	53.7	51.7	49.7	45.7
	800	0.25	66.0	62.0	58.0	55.0	53.0	51.0	47.0
	1000	0.25	67.0	63.0	59.0	56.0	54.0	52.0	48.0
	1200	0.25	67.8	63.8	59.8	56.8	54.8	52.8	48.8
	1400	0.25	68.4	64.4	60.4	57.4	55.4	53.4	49.4
FV-003	400	0.25	63.0	59.0	55.0	52.0	50.0	48.0	44.0
	600	0.25	64.7	60.7	56.7	53.7	51.7	49.7	45.7
	800	0.25	66.0	62.0	58.0	55.0	53.0	51.0	47.0
	1000	0.25	67.0	63.0	59.0	56.0	54.0	52.0	48.0
	1200	0.25	67.8	63.8	59.8	56.8	54.8	52.8	48.8
	1400	0.25	68.4	64.4	60.4	57.4	55.4	53.4	49.4
	636	0.25	65.0	61.0	57.0	54.0	52.0	50.0	46.0
FV-005	400	0.25	63.0	59.0	55.0	52.0	50.0	48.0	44.0
	600	0.25	64.7	60.7	56.7	53.7	51.7	49.7	45.7
	800	0.25	66.0	62.0	58.0	55.0	53.0	51.0	47.0
	1000	0.25	67.0	63.0	59.0	56.0	54.0	52.0	48.0
	1200	0.25	67.8	63.8	59.8	56.8	54.8	52.8	48.8
	1400	0.25	68.4	64.4	60.4	57.4	55.4	53.4	49.4
	1600	0.25	69.0	65.0	61.0	58.0	56.0	54.0	50.0
FV-006	600	0.25	64.7	60.7	56.7	53.7	51.7	49.7	45.7
	800	0.25	66.0	62.0	58.0	55.0	53.0	51.0	47.0
	1000	0.25	67.0	63.0	59.0	56.0	54.0	52.0	48.0
	1200	0.25	67.8	63.8	59.8	56.8	54.8	52.8	48.8
	1400	0.25	68.4	64.4	60.4	57.4	55.4	53.4	49.4
	1600	0.25	69.0	65.0	61.0	58.0	56.0	54.0	50.0
	1800	0.25	69.5	65.5	61.5	58.5	56.5	54.5	50.5
	2000	0.25	70.0	66.0	62.0	59.0	57.0	55.0	51.0
2150	0.25	70.3	66.3	62.3	59.3	57.3	55.3	51.3	

* Estimated sound power levels have been derived using the method described in the 1987 ASHRAE Systems & Applications Handbook, chapter 52, p. 52.7.

CFM – Cubic Ft Per Minute

ESP – External Static Pressure (in. w.c.)

RPM – Revolutions Per Minute

AIRFLOW PERFORMANCE CORRECTION FACTORS

HEATER kW	ELEMENTS	STATIC PRESSURE CORRECTION (in. wc)	
		Sizes 002-005	Size 006
0	0	+ .02	+ .03
5	1	+ .01	+ .02
8, 10	2	0	0
9, 15	3	- .02	- .03
20	4	- .04	- .06
18, 24, 30	6	- .06	- .10

The FV4C airflow performance table was developed using fan coils with 10-kW electric heaters (2 elements) in the units. For fan coils with heaters made up of a different number of elements, the external available static at a given CFM from the table may be corrected by adding or subtracting pressure. Use table for this correction.

FACTORY-INSTALLED FILTER STATIC PRESSURE DROP (in. wc)

UNIT SIZE	CFM								
	400	600	800	1000	1200	1400	1600	1800	2000
002	0.020	0.044	0.048	0.072	0.100	—	—	—	—
003	—	0.020	0.035	0.051	0.070	0.092	—	—	—
005	—	—	0.035	0.051	0.070	0.092	0.120	—	—
006	—	—	—	0.038	0.053	0.070	0.086	0.105	0.133

PERFORMANCE DATA (cont)

AIR DELIVERY PERFORMANCE CORRECTION COMPONENT PRESSURE DROP (IN. WC) AT INDICATED AIRFLOW (DRY TO WET COIL)

UNIT SIZE	CFM										
	600	700	800	900	1000	1100	1200	1300	1400	1500	1600
002	0.012	0.016	0.022	0.028	0.034	0.040	0.049	—	—	—	—
003	—	0.026	0.034	0.042	0.052	0.063	0.075	0.083	0.091	0.098	0.110
005	—	0.006	0.008	0.010	0.012	0.015	0.017	0.020	0.023	0.027	0.030
UNIT SIZE	CFM										
	1100	1200	1300	1400	1500	1600	1700	1800	1900	2000	2100
006	0.013	0.016	0.018	0.020	0.023	0.027	0.030	0.034	0.039	0.044	0.048

UNITS WITHOUT ELECTRICAL HEAT

UNIT SIZE	VOLTS—PHASE	FLA	MIN CKT AMPS	BRANCH CIRCUIT	
				Min Wire Size Awg*	Fuse/Ckt Bkr Amps
002	208/230-1	4.3	5.4	14	15
003	208/230-1	4.3	5.4	14	15
005	208/230-1	4.3	5.4	14	15
006	208/230-1	6.8	8.5	14	15

* Use copper wire only to connect unit. If other than uncoated (non-plated) 75°C copper wire (solid wire for 10 AWG and smaller, stranded wire for larger than 10 AWG) is used consult applicable tables of the National Electric Code (ANSI/NFPA 70).

NOTE: If branch circuit wire length exceeds 100 ft, consult NEC 210-19a to determine maximum wire length. Use 2% voltage drop.
FLA — Full Load Amps

ELECTRIC HEATERS

HEATER PART NO.	kW @ 240V	VOLTS/PHASE	STAGES (kW OPERATING)	INTERNAL CIRCUIT PROTECTION	FAN COIL SIZE USED WITH	HEATING CAP. @ 230V‡	INTELLIGENT HEAT CAPABLE†† (kW OPERATING)
KFCEH0501N05	5	230/1	5	None	All	15,700	—
KFCEH0801N08	8	230/1	8	None	All	25,100	—
KFCEH0901N10	10	230/1	10	None	All	31,400	—
KFCEH3001F15	15	230/1	5, 15	Fuses**	All	47,100	5, 10, 15
KFCEH3201F20	20	230/1	5, 20	Fuses**	All	62,800	5, 10, 15, 20
KFCEH2901N09	9	230/1*	3, 9	None	All	28,300	3, 6, 9
KFCEH1601315	15	230/3	5, 15	None	All	47,100	—
KFCEH2001318	18	230/3	6, 12, 18	None	All	56,500	—
KFCEH3401F24	24	230/3†	8, 16, 24	Fuses	005, 006	78,500	8, 16, 24
KFCEH3501F30	30	230/3†	10, 20, 30	Fuses	005, 006	94,200	10, 20, 30
KFCEH2401C05	5	230/1	5	Ckt Bkr	All	15,700	—
KFCEH2501C08	8	230/1	8	Ckt Bkr	All	25,100	—
KFCEH2601C10	10	230/1	10	Ckt Bkr	All	31,400	—
KFCEH3101C15	15	230/1	5, 15	Ckt Bkr	All	47,100	5, 10, 15
KFCEH3301C20	20	230/1	5, 20	Ckt Bkr	All	62,800	5, 10, 15, 20

* Field convertible to 3 phase.

† These heaters field convertible to single phase.

‡ Blower motor heat not included.

** Single point wiring kit required for these heaters in Canada.

†† Heaters designated with kW Operating Values are Intelligent Heat capable when used with compatible thermostat.

ELECTRIC HEATER INTERNAL PROTECTION

HEATER kW	FUSES QTY/SIZE	CKT BKR QTY/SIZE*
5	—	1/60
8	—	1/60
9	—	—
10	—	1/60
15	2/30, 2/60	2/60
15	—	—
18	—	—
20	4/60	2/60
24	6/60	—
30	6/60	—

* All circuit breakers are 2 pole.

EXPLORER

Digital Thermostat



4.6" w x 5.2" h x 1.1" d

Accessories: ACC-0625 Lock Ring, ACC-0425 Wall Plate, ACC-TSENWIFI Sensor and the wireless module below.



Simply connected.

Anytime. Anywhere.*

Apple and Android
mobile apps available

**This Wireless
Module available***



*Optional, not included
with thermostat



ACC-VWF1

VENSTAR
smartSM

standard features

- Gas/electric or heat pump – Multi-stage
- “Simple as you want Operation™”
 - Switchable: programmable or non-programmable
 - Switchable: auto changeover, or heat or cool only
- Large, easy to read display
- Scrolling display makes setup easy
- Adjustable backlight intensity
- Backlit, color coded buttons and legends
- Choice of English, French or Spanish for scrolling display
- Bi-color LED indicates a heating or cooling demand
- Dry contact input
- Outdoor sensor ready
- Random start
- Fahrenheit or Celsius display
- Service alert indicators
- Compatible with condensate overflow warning systems – lockout compressor with message on the display
- Keypad lock
- Non-volatile memory
- Wireless connectivity with optional accessory
- ADR (Automated Demand Response) ready
- FDD (Equipment Fault Protection) notification
- API for 3rd party monitor and control
- Night dimmer for brightness control in sensitive areas at night
- Configurator app to easily setup Wi-Fi and thermostat settings



model T4700

All of the standard features plus:

- Non-programmable
- 2 heat, 2 cool stages
- Controls to, or monitors a 2nd sensor
- Setpoint limiting
- Up to 4 hours override
- Controls humidification, dehumidification

model T4800

All of the standard features plus:

- 4 heat, 2 cool stages
- “Simple as you want Operation™”
 - Choose 7-day, 5+1+1 day or 1-day programming. Up to 3 occupied periods per day
- Adjustable deadbands and timers between stages
- Outdoor sensor ready with high/low temps for the day
- Smart fan operation
- Holiday mode
- Smart recovery
- 365 day holiday programming (when connected to Skyport)
- Title 24 Compliant

model T4900

All of the T4800 features plus:

- Control to or monitor a 2nd temperature sensor
 - Can also average 1 remote sensor with the thermostat sensor
- Controls humidification, **dehumidification** and reheat
- Pre-occupancy fan purge
- Programmable extra output
- Light activated
- Energy watch
- Title 24 Compliant



Industry
Canada

Industrie
Canada





FREE Services

... help you connect to your Explorer thermostats (with Wi-Fi)



With our FREE app, access all these features remotely from your mobile device

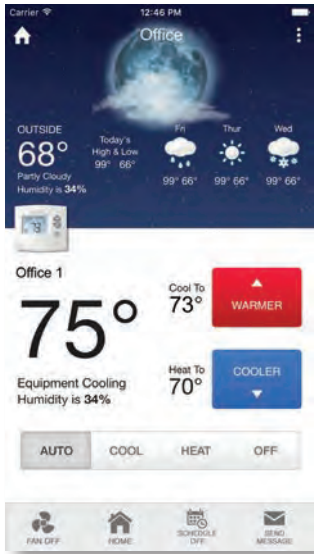

View Thermostat Information

- Name & location of the thermostat
- Current weather & forecast
- Change heat & cool setpoints
- Change thermostat modes
- View equipment status: heating, cooling, off – including lockouts

Enable or Disable the Time Period Schedule

View Thermostat Alerts

- Supply air temperature**
- Time for service
- Air filter replacement
- Humidity pad replacement
- UV light bulb replacement

Send Text Messages to the Thermostat

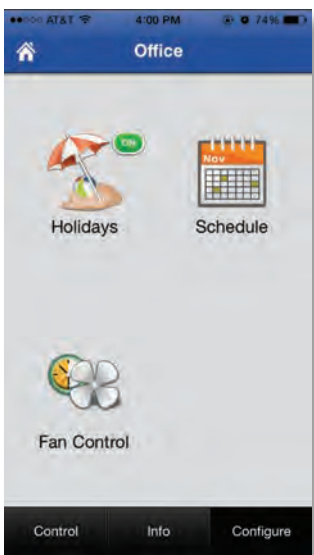

View Current System Temperatures with High and Low Values for the Day

- Indoor temperature
- Indoor humidity*
- Outdoor temperature
- Remote temperature**
- Supply air temperature**
- Return air temperature**

View Heating & Cooling Runtimes for the Day, Current Week, and Last Week

*T4700 & T4900 Only
 **Remote Sensor required for this feature

FREE Additional Features available from the Skyport web site:

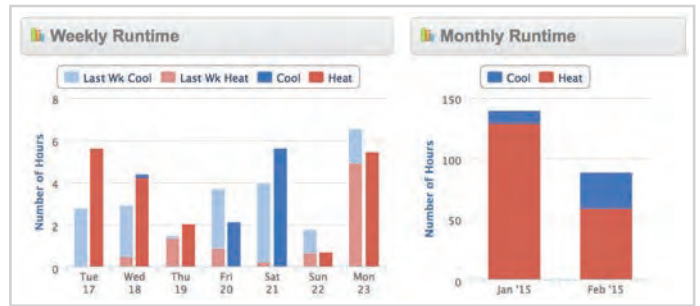

View Daily, Weekly, and Monthly Runtime Graphs

Advanced Configuration

- Stage deadbands
- Stages of cooling & heating
- Hum/dehum setpoints*
- Thermostat language
- Readout in degrees F or C
- Display brightness

Program Time Period Schedules Security Settings

- Set view only access
- Disable mode changes
- Disable/enable override
- Enable setpoint limits

Enable Popular Holidays at the Touch of a Button

Program Custom Holidays up to 20 Years in Advance

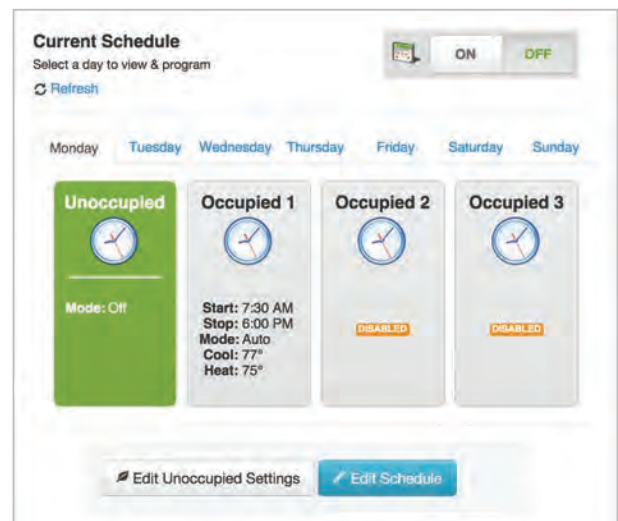



Performance Coatings & Finishes

PSX[®] 700



Engineered Siloxane coating

PSX 700 Series

Patent Nos. 5,618,860 and 5,275,645

PSX[®] Advantage: PSX[®] 700 is the world's first weatherable epoxy it embodies the properties of both a high-performance epoxy and an acrylic polyurethane in one coat. This multi-purpose coating offers "breakthrough" weather resistance and corrosion control.

Product Data/ Application Instructions

- Unique, high-gloss, self-priming coating
- Can be applied directly over inorganic zinc
- Gloss and appearance retention exceeding the best polyurethane
- Significantly lower applied costs
- Excellent resistance to acid and corrosion
- High solids, low VOC
- Resists high humidity and moisture
- Applied by brush, roller or spray—without thinning
- Outstanding resistance to chemical splash and spill

Typical Uses

PSX 700 adheres strongly to bare steel, coated steel and inorganic zinc silicate coated surfaces on new construction, repair and field maintenance coating projects. It provides effective long-term corrosion control and weatherability.

- Structural steel
 - Bridges –Marine
- Tanks
- Piping
- Industrial power plants
 - Power – Wastewater treatment
 - Pulp and paper – Chemical and petrochemical
- Concrete walls and floors
- Transportation
 - Rail car exterior – Vehicle equipment—buses, trucks
- Marine
 - Decks – Topside and superstructures on ships
 - Boottops – Barges and offshore platforms

Physical Data

Finish	Gloss	
Color	See color card	
<i>Yellow, red and orange colors will fade faster than other colors due to the replacement of lead-based pigments with lead-free pigments in these colors.</i>		
Components	2	
Curing mechanism	Chemical reaction	
Volume solids (calculated)		
PSX 700	90% ± 3%	
PSX 700FD	90% ± 3%	
Dry film thickness per coat	3 – 7 mils (75 – 175 microns)	
Coats*	1 or 2	
Theoretical coverage	ft ² /gal	m ² /L
1 mil (25 microns)	1444	35.5
3 mils (75 microns)	481	11.8
5 mils (125 microns)	289	7.1
7 mils (175 microns)	206	5.1
VOC**	lb/gal	g/L
700 & 700FD (EPA method 24)	1.0	120
700 & 700FD mixed/thinned (calculated) (1 pt/gal)	1.7	204
Temperature resistance, dry	°F	°C
continuous	200	93
intermittent	250	121
Flash point (SETA)	°F	°C
resin	207	97
cure	205	96
FD cure	180	82
Amercoat 12	2	-17
Amercoat 65	81	27
Amercoat 101	145	63

Qualifications

NFPA – Class A
USDA – Incidental food contact

* When applying more than one coat, it is recommended that total dry film thickness not exceed 10 mils.

**The mixed and applied coating cure reaction will produce VOC of mixed alcohols.

Typical Properties

Physical

Abrasion resistance (ASTM D4060)	
1 kg load/1000 cycles	weight loss
CS-17 wheel	53 mg
Adhesion, elcometer	
(ASTM D4541)	2700 psi
Elongation (ASTM D522)	14%

Performance

Salt spray (ASTM B117)	
Face corrosion, blistering	None
Humidity (ASTM D2247)	
Face corrosion, blistering	None
Gloss retention (ASTM G53) QUV-B bulb	
Greater than 50% gloss retention at 26 weeks	

Chemical Resistance Guide

Environment	Splash and Spillage	Fumes and Weather
Acidic	E	E
Alkaline	E	E
Salt solutions		
acidic	E	E
neutral	E	E
alkaline	E	E
Fresh water	E	E
Solvents	E	E
Petroleum products	E	E
F-Fair	G-Good	E-Excellent

This table is only a guide to show typical resistances of PSX® 700. For specific recommendations, contact your Ameron representative for your particular corrosion protection needs.

Systems Using PSX 700 or 700FD

Substrate	Coats	DFT per coat
Steel (blasted)		
Intact coating	1	3
Dimetcote [†]	1	4-6
Amercoat 68HS [†] , 370 or 385	1	3-5
Amerlock Series	1	3-5
Concrete ^{††}		
Amercoat 385, Amerlock Series	1	3-5
Masonry		
Amerlock 400BF	1	3-5
Nu-Klad 965	1	3-5

[†] Mist-coat/full-coat application may be required. See special thinning instructions.

^{††} Fill voids with Nu-Klad 114A prior to applying Amercoat 385, Amerlock Series.

Application Data

Applied over**	Prepared or primed steel, primed concrete, prepared galvanizing or aluminum
Surface preparation	SSPC-SP5, 6 or 10
steel	ASTM D4259 or 4260
concrete	Galvaprep or blast lightly
galvanizing	Alumiprep or blast lightly
aluminum	Contact your Ameron representative
aged coatings	Nu-Klad® 105A, Dimetcote® 9 Series, Dimetcote® 21-5, Amerlock® Series, Amercoat 68HS, 351, 370, 385, 395FD
Primers	

Method	Airless or conventional spray, brush or roller
Mixing ratio (by volume)	4 parts resin to 1 part cure
Pot life (hours) [‡]	°F/°C
	90/32 70/21 50/10
700 & 700FD	1½ 4 6½

[‡] Thinning material with ½ pt/gal after 3 hours will extend pot life to 5 hours at 70°F.

Environmental Conditions

Temperature	°F	°C
air	40 to 120	4 to 49
surface	40 to 120	4 to 49
Relative humidity	40% minimum	

Surface temperatures must be at least 5°F (3°C) above dew point to prevent condensation during application and initial dry through. Relative humidity lower than 40% will extend dry times.

Heat curing

Allow 700 or 700FD to dry to touch before exposing to curing temperatures above 140°F.

Drying time (ASTM D1640) (hours) @ 40% R.H. or above

	°F/°C			
	90/32	70/21	50/10	32/0
touch (700)	1½	3	6	12
touch (700FD)	1	2	4½	9
through (700)	4	6	11	38
through (700FD)	3	4½	8½	24

Recoat/topcoat time (hours) @ 40% R.H. or above

	°F/°C			
	90/32	70/21	50/10	32/0
minimum (700 over 700)	3	4½	9	32
minimum (700FD over 700FD)	2	3	7	18
maximum ^{††}	None			

Thinner Amercoat 65 or 101

Equipment cleaner Thinner or Amercoat 12

^{††} See surface preparation for aged coatings.

** Appearance will vary depending on substrate and application method. Use two coats of PSX® 700 over bare concrete.

Surface Preparation

Coating performance is, in general, proportional to the degree of surface preparation. Refer to specifications for the specific primer being used. Prior to coating, primed surface must be clean, dry, undamaged and free of all contaminants including salt deposits. Round off all rough welds and remove all weld spatter.

Steel – Remove all loose rust, dirt, grease or other contaminants by one of the following depending on the degree of cleanliness required: SSPC-SP6 or 10. The choice of surface preparation will depend on the system selected and end-use service conditions.

Concrete – Acid etching (ASTM D4260) or abrasive blast (ASTM D4259) new concrete before priming.

Aluminum – Remove oil, grease or soap film with neutral detergent or emulsion cleaner, treat with Alodine® 1200, Alumiprep® or equivalent or blast lightly with fine abrasive.

Galvanizing – Remove oil or soap film with detergent or emulsion cleaner, then use zinc treatment such as Galvaprep® or equivalent or blast lightly with fine abrasive.

Aged coatings – Contact your Ameron representative. A test patch of PSX® 700 over intact clean coating and observation for film defects over a period of time may be required, dependant upon the type of aged coating.

PSX® 700 is compatible over Amercoat 450HS and Amershield.

Repair – Prepare damaged areas to original surface preparation specifications, feathering edges of intact coating. Thoroughly remove dust or abrasive residue before touch up.

Application Equipment

The following is a guide; suitable equipment from other manufacturers may be used. Changes in pressure, hose and tip size may be needed for proper spray characteristics.

Airless spray – Standard equipment with a 30 to 1 pump ratio or larger with a 0.015- to 0.021-in. (0.38 to 0.53 mm) fluid tip.

Conventional spray – Industrial equipment such as DeVilbiss MBC or JGA spray gun with 78 or 765 air cap and “E” fluid tip, or Binks No. 18 or 62 gun with a 66 x 63 PB nozzle set up. Separate air and fluid pressure regulators, and a moisture and oil trap in the main air supply line are recommended.

Power mixer – Jiffy Mixer powered by an air or an explosion-proof electric motor.

Brush – Natural bristle. Maintain wet edge.

Roller – Use industrial roller. Level any air bubbles with bristle brush.

Environmental Conditions

Temperature	°F	°C
air	40 to 120	4 to 49
surface	40 to 120	4 to 49
Relative humidity	40% minimum	

Surface temperatures must be at least 5°F (3°C) above dew point to prevent condensation during application and initial dry through. Relative humidity lower than 40% will extend dry times.

Heat curing

Allow 700 to dry to touch before exposing to curing temperatures above 140°F.

Application Procedure

Adhere to all application instructions, precautions, conditions, and limitations to obtain the maximum performance. For conditions outside the requirements or limitations described, contact your Ameron representative.

1. Flush equipment with thinner or Amercoat® 12 before use.
2. Mix to a uniform consistency.
3. Add PSX® 700 cure to 700 resin. Mix thoroughly until uniformly blended.

Pot life (hours)*	°F/°C		
	90/32	70/21	50/10
700 & 700FD	1 ½	4	6 ½

4. If needed for workability, thin** with Amercoat 65 or 101 up to 1 pint per gallon PSX® 700.
5. Apply a wet coat in even, parallel passes, overlap each pass 50 percent to avoid holidays, bare areas and pinholes. If required, follow with a cross spray at right angles to first pass.

Drying time (ASTM D1640) (hours) @ 40% R.H. or above	°F/°C			
	90/32	70/21	50/10	32/0
touch (700)	1 ½	3	6	12
touch (700FD)	1	2	4 ½	9
through (700)	4	6	11	38
through (700FD)	3	4 ½	8 ½	24

Recoat/topcoat time (hours) @ 40% R.H. or above	°F/°C			
	90/32	70/21	50/10	32/0
minimum (700 over 700)	3	4 ½	9	32
minimum (700FD over 700FD)	2	3	7	18

6. Brush and/or roll applications will require 2 coats to achieve a 7 mil DFT. There will be some surface texture, which is typical for brush and roll applications.
7. When applying PSX® 700 directly over Dimetcote® or Amercoat 68HS see special thinning instructions.
8. Clean all equipment with thinner or Amercoat 12 cleaner immediately after use.

*Thinning material with ½ pt/gal after 3 hours will extend pot life to 5 hours at 70°F.

**See special thinning for application over Dimetcote and Amercoat 68HS primers.

***See surface preparation for aged coatings.

Thinning for Application over Dimetcote

Thin PSX® 700 with Amercoat 65 or 101 up to 1 pint per gallon to assist in film thickness control and to minimize bubbling. This will depend on the age of the coating, surface roughness and conditions during curing. Based on conditions an interval between the mist-coat and full-coat may assist in the application.

Safety Precautions

Read each component's material safety data sheet before use. Mixed material has hazards of each component. Safety precautions must be strictly followed during storage, handling and use.

CAUTION – Improper use and handling of this product can be hazardous to health and cause fire or explosion.

Do not use this product without first taking all appropriate safety measures to prevent property damage and injuries. These measures may include, without limitation: implementation of proper ventilation, use of proper lamps, wearing of proper protective clothing and masks, tenting and proper separation of application areas. Consult your supervisor. Proper ventilation and protective measures must be provided during application and drying to keep spray mists and vapor concentrations within safe limits and to protect against toxic hazards. Necessary safety equipment must be used and ventilation requirements carefully observed, especially in confined or enclosed spaces, such as tank interiors and buildings.

This product is to be used by those knowledgeable about proper application methods. Ameron makes no recommendation about the types of safety measures that may need to be adopted because these depend on application environment and space, of which Ameron is unaware and over which it has no control.

If you do not fully understand these warnings and instructions or if you cannot strictly comply with them, do not use the product.

Note: Consult Code of Federal Regulations Title 29, Labor, parts 1910 and 1915 concerning occupational safety and health standards and regulations, as well as any other applicable federal, state and local regulations on safe practices in coating operations.

This product is for industrial use only. Not for residential use.

Warranty

Ameron warrants its products to be free from defects in material and workmanship. Ameron's sole obligation and Buyer's exclusive remedy in connection with the products shall be limited, at Ameron's option, to either replacement of products not conforming to this Warranty or credit to Buyer's account in the invoiced amount of the nonconforming products. Any claim under this Warranty must be made by Buyer to Ameron in writing within five (5) days of Buyer's discovery of the claimed defect, but in no event later than the expiration of the applicable shelf life, or one year from the delivery date, whichever is earlier. Buyer's failure to notify Ameron of such nonconformance as required herein shall bar Buyer from recovery under this Warranty.

Ameron makes no other warranties concerning the product. No other warranties, whether express, implied, or statutory, such as warranties of merchantability or fitness for a particular purpose, shall apply. In no event shall Ameron be liable for consequential or incidental damages.

Any recommendation or suggestion relating to the use of the products made by Ameron, whether in its technical literature, or in response to specific inquiry, or otherwise, is based on data believed to be reliable; however, the products and information are intended for use by Buyers having requisite skill and know-how in the industry, and therefore it is for Buyer to satisfy itself of the suitability of the products for its own particular use and it shall be deemed that Buyer has done so, at its sole discretion and risk. Variation in environment, changes in procedures of use, or extrapolation of data may cause unsatisfactory results.

Limitation of Liability

Ameron's liability on any claim of any kind, including claims based upon Ameron's negligence or strict liability, for any loss or damage arising out of, connected with, or resulting from the use of the products, shall in no case exceed the purchase price allocable to the products or part thereof which give rise to the claim. **In no event shall Ameron be liable for consequential or incidental damages.**

Shipping Data

Packaging unit	1-gal	5-gal
cure	0.20 gal in 1-qt can	1 gal in 1-gal can
FD cure	0.20 gal in 1-qt can	1 gal in 1-gal can
resin	0.80 gal in 1-gal can	4 gal in 5-gal can
Shipping weight (approx)	lb	kg
1-gal unit		
cure	2.0	0.9
FD cure	1.8	0.8
resin	10.3	4.7
5-gal unit		
cure	9.0	4.1
FD cure	8.9	4.0
resin	50	22.7

Shelf life when stored indoors at 40 to 100°F (4 to 38°C)

resin and cure 1 year from shipment date

Numerical values are subject to normal manufacturing tolerances, colors and testing variances. Allow for application losses and surface irregularities.

This product is photochemically reactive as defined by the South Coast Air Quality Management District's Rule 102 or equivalent regulations.



Ameron U.S.A. • 13010 Morris Rd, Suite 400, Alpharetta, GA 30004 • (678) 393-0653

Ameron B.V. • J.F. Kennedylaan 7, 4190 CA Geldermalsen, The Netherlands • (31) 345-587-587

BLYGOLD PoluAl

Protective Coating for HVAC/R Coils

Corrosion protection applied to
condenser coil -accu1&2



Exposed to Corrosion

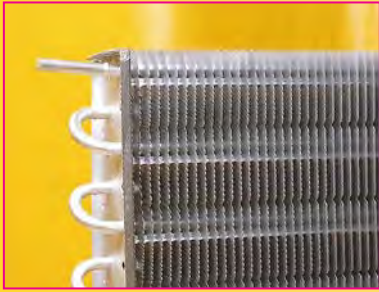

Protected with PoluAl

BLYGOLD:

Blygold was established in the Netherlands over twenty-five years ago in response to a market demand for more effective coating products for HVAC/R applications. From its origin, Blygold has been developing protective coatings specifically engineered for HVAC/R coils and equipment that are installed in corrosive marine and industrial environments.

The unique capabilities of Blygold products combined with Blygold's global network of licensed applicators, have made Blygold the global leader in the protective coatings market for HVAC/R coils.

The PROBLEM is CORROSION:

Coil manufacturers are continually designing more efficient coils by utilizing higher fin densities and enhanced fin geometries. As a result, increasingly thinner metals are utilized that have greater surface exposure to corrosive influences.

Once corrosion starts to develop, a unit's capacity decreases rapidly resulting in reduced efficiency and increased energy consumption. In some conditions, the operating performance of unprotected coils can decrease by over 30% in less than 6 months.

The SOLUTION is BLYGOLD PoluAl:

Blygold PoluAl is a metallic impregnated polyurethane coating specifically designed for application to aluminum finned-copper tube coils. It is a thin (25 microns), flexible, UV and impact resistant coating that exhibits excellent adherence to aluminum surfaces. PoluAl protects the parent metal against a wide range of corrosive salts, acids, and other elements found in the atmosphere and provides protection superior to that of Cu/Cu coils.

In addition to a superior ability to resist corrosion, the unique characteristics of PoluAl result in it having only a negligible effect on pressure drop, and heat transfer (k value) of the coated coil. The HVAC/R unit coated with PoluAl receives all the benefits of corrosion protection without losing operating efficiency.



3-YEAR WARRANTY:

Blygold guarantees protection for HVAC/R coils with a standard 3-year conditional warranty for Blygold PoluAl applied on aluminum-finned, copper-tube coils by certified Blygold licensed applicators.

Protective Coatings for HVAC/R Coils & Equipment

When HVAC/R equipment is installed near coastal or industrial areas, the coil's finned surfaces are exposed to salts and other corrosive substances as air passes through the coils during operation.

www.blygoldamerica.com



Blygold

Field of Application:

Applicable to aluminum-finned, copper-tube condenser/evaporator coils and heat exchanger coils.

Typical Applications:

- Coastal, Marine, & Offshore Environments
- Waste Water Treatment Facilities
- Pulp & Paper Mills
- Mining & Drilling Operations
- Refineries & Heavy Manufacturing
- Pharmaceutical & Chemical Plants
- Semiconductor & Photo Film Manufacturing
- Meat & Dairy Processing
- Hog & Mushroom Farms
- Swimming Pool Applications
- Commercial Refrigeration
- Various Other Corrosive Environments

Characteristics:

Conversion Layer	Chromate Free
Topcoat	Metallic Impregnated Polyurethane
Color	Silver
Dry Film Thickness	20–25 Microns = 1 Mil (Approximately)
Temperature Rating	up to 194° F (up to 90° C)
pH Range	3 – 12
Cross Hatch Adhesion ASTM D5339	4B – 5B

Accelerated Testing:

Salt Spray Test ASTM B117	3000 Hours +
Acid Salt Spray Test ASTM G85 (Formerly - B287)	3000 Hours +
Kesternich DIN 50018-SFW 2.0S (2 liters SO ₂)	80 Cycles



Blygold America, Inc.
P.O. Box 759
Stevensville, MD 21666
Phone: 410-643-6080
Fax: 410-643-6092
Email: info@blygoldamerica.com

BLYGOLD PoluAl

Protective Coating for HVAC/R Coils

Advantages:

Aluminum Impregnated Polyurethane	UV Resistant Highly Flexible Sheds Water Negligible Effect on Heat Transfer (k value)
Superior Adhesion	No Cracking or Flaking Highly Impact Resistant
100% Coverage	Covers All Finned Surface Area and Cut Edges
Extremely Thin	No Bridging Negligible Effect on Pressure Drop
Field Tested Corrosion Protection	Years of Successful PoluAl Applications in over 30 Countries
Energy Savings	Corroded Coils Cause Rapid Declines in HVAC/R Energy Efficiency
Application Process	Fast Turn-Around Time Able to Coat Most Units Without Removing Coils Environmentally Safe
Warranty	3-Year Standard (Conditional)

Application Process:

1. Inspection & Cleaning
2. Fin Alignment
3. De-Oxidizing
4. Rinsing
5. Conversion Layer
6. Drying
7. PoluAl Topcoat

PoluAl Specification:

Aluminum Impregnated Polyurethane Coating:

The coating manufacturer shall be able to document the successful completion of accelerated product testing of a minimum 3000 hours in both salt spray (ASTM B117) and acid salt spray tests (ASTM G85); and shall be able to provide a 3-year conditional warranty for the coating applied on aluminum-finned, copper tube coils. The product application process shall include the application of a chromate-free conversion layer applied to the coil that achieves total coverage and penetration. An aluminum-impregnated polyurethane topcoat shall be applied that ensures total penetration and coverage without bridging or significantly affecting the heat transfer ability of the coil. The total dry film thickness of the topcoat shall be 20 to 25 microns (0.020 to 0.025 mm). The coating shall provide protection against ultraviolet radiation and be temperature resistant up to 194°F (90°C).

Some Organizations Using Blygold PoluAl:

- Carrier
- Trane
- Lennox
- York
- McQuay
- Mitsubishi
- Shell
- ARAMCO
- IBM
- KLM
- Verizon
- State of Hawaii
- U.S. Army
- U.S. Air Force
- U.S. Navy
- U.S. Marine Corps

1



2



3

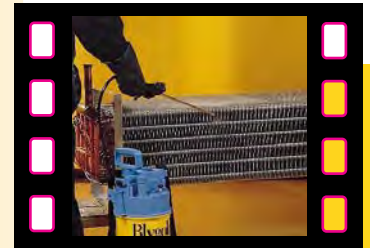

4

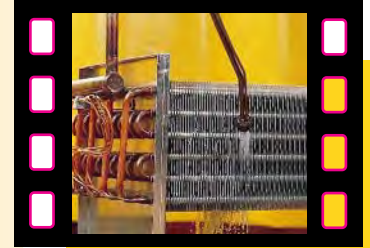

5

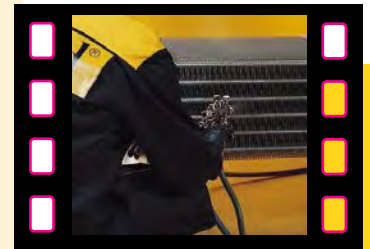

6



7

